

WARNER®

America's leading brand of
Paint and Drywall Tools
for the Professional

2024
Decorating & Maintenance
Tool Catalog

800-444-0606
www.warnertool.com

Warner Vision: We call it the Warner Way. We're SMARTER, STRONGER AND BETTER at making tools and giving our customers the support they need to be successful.

Smarter: We listen to our customers and consumers to develop tools that fit their needs to ensure they will be successful in the market place. Ultimately for us, the proof that we are smarter at our business is in the design of our tools, their durability and their ease of use.

Stronger: We enjoy pushing our innovations from good to great. Even in areas where we have the strongest products, we keep generating ways to make them better. Our company began in 1927, and our staying power is a testament to our strength. Our tools are made tough and strong by people who are tough and strong.

Better: Our goal is to give our customers the best customer service the industry has to offer and to give consumers the best information they need to complete their projects. We live by the creed be honest, trustworthy and loyal. This represents the Warner Way of dealing with our customers.

History: Harry H. Warner who founded Warner Tool Products in 1927 used to say the only thing you have that is worth anything is your name. To keep your name, you've got to provide customers value and put every customer first. The Warner family still runs the company this way, four generations later. If it's got our name on it, it works.

Innovation:

Warner's innovation has demonstrated that Warner is the leader in the Paint Tool Category, and the commitment to continue developing industry leading products.



Items shaded in Blue denote Made in the USA

Are you interested in items made in the USA? We are very proud to offer items made in America.

Please note the items with blue shading are made in the USA!

Putty Knives and Scrapers

PROGRIP®	4-7
PROGRIP® Stainless Steel	7
American Pride Series	7
Mexican Heritage Series	7
Wood Series Carbon Steel	8
Wood Series Stainless Steel	9
12-in-1 Folding Knife	9
15-in-1 Painter's Tool	9
DIY Series	10
Painter's Series	11
Plastic Series	10
Perfect Pass™ Joint Knife	11
Miscellaneous Knives and Scrapers	10

Paint Scrapers

Carbide 100X® Scrapers	12
Carbide 100X® Scrapers—Softgrip Handle	12
Carbide 100X® Replacement Blades	12
2-Edge Steel Blade Paint Scrapers	13
4-Edge Steel Paint Scrapers	13
2- and 4-Edge Replacement Blades	13
Blade Sharpening File	13
Specialty Scrapers and Replacement Blades	14
Plastic Refinishing Tool	14
Dual Blade Paint Scraper	14
Heavy-Duty Scrapers—Carbon Steel and Stainless Steel	14
Threaded Scrapers—Carbon Steel and Stainless Steel	14
Strip 'N' Clean™ Scrapers and Replacement Blades	15
Big Blade Scrapers & Replacement Blades	15

Glass & Razor Scrapers, and Single Edge Blades

Premium Safety 1st™ Scrapers	16
Razor Scrapers	16
Single Edge Razor Blades	16
Utility Blades	16

Snap-Off Knives & Blades

Snap-Off Blade Knives	17
Snap-off Replacement Blades	17

Utility Knives & Utility Blades

Utility Knives	17
----------------	----

Extension Poles

Steel Poles	18
-------------	----

Hopper Gun

Hopper Gun	18
------------	----

Pliers, Screwdriver & Tape Measure

Pliers, Screwdriver & Tape Measure	18
------------------------------------	----

Paint Test Set, Sheets & Panels

Paint Test Set, Sheets & Panels	18
---------------------------------	----

Spray Shields & Paint Accessories

Spray Shields—Aluminum, Plastic & Cardboard	19
Brush Extension	19
Miscellaneous Paint Accessories	19
Wood Paint Paddle	19
Paint and Trim Guides	20
Pry Bars	20
Bucket Openers	20
Mixers	20
Strainer Bag Squeegee and Pail Scoop	20
Plastic Buckets	21
Paint Grid & Roller Trays	21
Brush and Roller Cleaners	21
3-in-1 Paint Tote & Liners	21
Can-Do Grip 1-Gallon Paint Can Carriers	21
Wire Brushes—Soft Grip & Wood Handle	22

Stilts and Benches

Strap-N-Stride™ Aluminum Stilts and Rplcmt Parts	23
EZ-Stride® Step-Up Benches and Rplcmt Parts	24
EZ-Stride® Drywall Bench and Rplcmt Parts	25

Taping Knives

PROGRIP® - Blue Steel & Stainless Steel	26
Aluminum Backing Plate—Poly Handle, Blue Steel & SS	26
PROGRIP® Mexican Heritage Taping Knives	27
Bucket Scoop	28
Perfect Pass™ Joint Knife	29
Painter's Series and Plastic Series Joint Knives	27
Corner and Curved Trowels	29

Drywall Tools & Tile Tools

Mud Pans, Grip & Go™ Mud Pan	29
Hand Sanders	28
Sanding Blocks	28
Pole Sanders	28
Drywall Saw	28
Hawkbill Knife	30
Rubber Float & Grout Sponge	30
Applicator Brush	30
No Pock!™	29
Adhesive Spreaders	30

Wallcovering Tools

Smoothers, Brushes	31
Wallcovering Kit	31
Seam Rollers	31
Razor Knife	31
Wallcovering Tools & Accessories	31

Assortments and Displays

Bucket Tree	32
Bucket Displays	33
Countertop Displays	33
Plastic Series Display	34
DIY Display	34
Painter's Series Display	34
Rosewood Display	34
2' Putty Knife & Sundry Assortment	35
Wire Brush Display	35
PROGRIP® Assortments	36-37

Bull Dog Power Products® Lighting **38-45****Index** **46-47**

Read and follow any safety related information in or on the product and packaging

PROGRIP®

Patented Color-Coding Handle Technology*

Customizable Inserts

The PROGRIP® line uses a patented color-coded handle system to identify blade flexibility: Stiff, Flex, Full Flex. Matched color-coded icons on the labels demonstrate usages. This at-a-glance identification helps customers select the right tools for their needs and makes for easier, faster sales for you. The PROGRIP line features:

- Ergonomic, color-coded soft grip handles
- Polypropylene with a TPE (Thermoplastic Elastomer) overmold
- Two soft-grip handle styles, Push & Pull
- Two cap styles
- Color coded blade flex on handle
- Three blade-flexibility options
- High-quality carbon steel blades
- Full tang
- Plated Zinc Hammer Cap™ on select models
- Dura Cap™ on select models
- Chisel-edge on stiff knives
- Large hang-hole size
- **Made in U.S.A.**

FOR SCRAPING AND REMOVAL



Red Handle = Stiff

Heavy-duty blades provide maximum strength and have a chisel ground edge. For fine scraping and shaving with less gouging or chipping. Standard blades are .050" thick and heavy-duty blades are .080" thick. Ergonomic handles have a ribbed finger grip for better pushing control.



STIFF

Item #	Description	Type of Packaging	Pack Weight	Pack Qty
90101	1-1/4" Stiff Chisel Putty Knife, .080"	Labeled	3	5
90107	1-1/4" Stiff Putty Knife	Labeled	2	5
90109	1-1/2" Stiff Putty Knife	Labeled	2	5
90111	2" Stiff Putty Knife	Labeled	2	5



STIFF

Item #	Description	Type of Packaging	Pack Weight	Pack Qty
90115	3" Stiff Scraper	Labeled	4	5
90175	3" Stiff Scraper, with Hammer Cap™	Labeled	3	5
90119	4" Stiff Scraper	Labeled	2	5

STIFF

Item #	Description	Type of Packaging	Pack Weight	Pack Qty
90173	8-in-1 Painter's Tool, Hammer Cap™, .060", Scraper, Roller Cleaner, Spreader, Crack Cleaner, Can Opener, Nail Setter, Nail Puller, & Utility Knife	Labeled, 10/Counter Unit	3.0	10
90189	5-in-1 Painter's Tool, .080" Scraper, Roller Cleaner, Spreader, Crack Cleaner, & Can Opener	Labeled, 10/Counter Unit	2.4	10
90199	6-in-1 Painter's Tool, Hammer Cap™, .080", Scraper, Roller Cleaner, Spreader, Crack Cleaner, Can Opener, & Nail Setter	Labeled, 10/Counter Unit	3.0	10



STIFF

Item #	Description	Type of Packaging	Pack Weight	Pack Qty
10971	5-in-1 Painter's Tool, 10/Counter Unit American Craftsman, Red, White, Blue	Labeled, 10/Counter Unit	2.4	10
11102	8-in-1 Painter's Tool, Black Blade, 10/Counter Display	Labeled	2.8	10
10830	7-in-1 Spray Wrench, .080", 10/Counter Display	Labeled	2.6	10



Items shaded in Blue denote Made in the USA

* US Patent Numbers **6,668,751 & 9,610,679**. Additional patents pending. The patent color-coding identification technology is unique to Warner PROGRIP® and Warner Tool Products.

PROGRIP®

Blue Handle = Flex

Standard carbon steel blades are hollow ground to provide consistent flex and proper stiffness for spreading heavy drywall compound. Ideal for first-coat applications. Ergonomic handles are designed to fit the hand more comfortably, for use as a spreading tool and to reduce fatigue. Some models available with Hammer Cap™. Angled blades reach into corners, help keep hands away from wall.



FOR SPREADING
AND APPLYING



FLEX

Item #	Description	Type of Packaging	Pack Weight	Pack Qty
90106	1-1/4" Flex Putty Knife	Labeled	2	5
90108	1-1/2" Flex Putty Knife	Labeled	2	5
10351	+Painter's Knife, 1-1/2"	Labeled	2	5
90110	2" Flex Putty Knife	Labeled	2	5
90114	3" Flex Putty Knife	Labeled	3	5



FLEX

Item #	Description	Type of Packaging	Pack Weight	Pack Qty
90118	4" Flex Joint Knife	Labeled	2	5
90124	4" Flex Joint Knife, Hammer Cap™	Labeled	2	5
90120	5" Flex Joint Knife	Labeled	2	5
90125	5" Flex Joint Knife, Hammer Cap™	Labeled	2	5
90122	6" Flex Joint Knife	Labeled	2	5
90126	6" Flex Joint Knife, Hammer Cap™	Labeled	2	5

1 1/4"

STIFF

+90100
90101
90107

FLEX

90106

FULL FLEX

90131

1 1/2"

90109
90661

90108
90660
10351

90127

2"

90111

90110

90128

3"

90115
90175
90662

90114
90663

90133

4"

90119
90667

90118
90124
90664

90135

5"

90120
90125
90665

90136

6"

90122
90126
90666

90137

5-in-1

90189

6-in-1

90199
10199

8-in-1

90173
10173

15-in-1

10309
10495

Painter's
Wrench

90200
10793

For
Scraping
and
Removal

For
Spreading
and
Applying

Applying
Lightweight
Spackling

Items shaded in Blue denote Made in the USA



Use 1-1/4"-2"

Knives to apply spackle, putty and for detail work in smaller areas.

Use 3"

Knives for patching, touch-up and heavy-duty scraping.

Use 4" - 6"

Knives for taping drywall joints and large surface scraping

Use a **multi-purpose** tool to scrape, clean and glaze.

PROGRIP®

Yellow Handle = Full Flex

Full Flex applies to blades that have been hollow-ground thinner for maximum flexibility. They are designed for lighter compounds. Perfect choice for final or finish-coat applications. Ergonomic handle is wider and flatter, designed to fit the hand for use as a spreading tool and to reduce fatigue. Design improves blade control.

Customizable Inserts

FOR APPLYING LIGHTWEIGHT SPACKLING



FULL FLEX

Item #	Description	Type of Packaging	Pack Weight	Pack Qty
90131	1-1/4" Full Flex Putty Knife	Labeled	2	5
90127	1-1/2" Full Flex Putty Knife	Labeled	2	5
90128	2" Full Flex Putty Knife	Labeled	2	5
90133	3" Full Flex Putty Knife	Labeled	2	5



FULL FLEX

Item #	Description	Type of Packaging	Pack Weight	Pack Qty
90135	4" Full Flex Joint Knife	Labeled	2	5
90137	6" Full Flex Joint Knife	Labeled	2	5

Stainless Steel Blades

Same great PROGRIP® features and color-coded handle system with high-quality stainless steel blades. Available in Stiff and Flex blades. All have a Hammer Cap™ and eye-catching silver label for retail appeal.



STIFF—STAINLESS—HAMMER CAP™

Item #	Description	Type of Packaging	Pack Weight	Pack Qty
90661	1-1/2" Stainless Steel Stiff Putty Knife, Hammer Cap™	Labeled	2	5
90662	3" Stainless Steel Stiff Scraper, Hammer Cap™	Labeled	2	5
90667	4" Stainless Steel Stiff Scraper, Hammer Cap™	Labeled	3	5



FLEX—STAINLESS—HAMMER CAP™

Item #	Description	Type of Packaging	Pack Weight	Pack Qty
90660	1-1/2" Stainless Steel Flex Putty Knife, Hammer Cap™	Labeled	2	5
90663	3" Stainless Steel Flex Putty Knife, Hammer Cap™	Labeled	2	5
90664	4" Stainless Steel Flex Joint Knife, Hammer Cap™	Labeled	3	5
90665	5" Stainless Steel Flex Joint Knife, Hammer Cap™	Labeled	3	5
90666	6" Stainless Steel Flex Joint Knife, Hammer Cap™	Labeled	3	5



Items shaded in Blue denote Made in the USA

PROGRIP®

American Pride and Mexican Heritage

These flex bladed tools are made with pride to honor American and Mexican craftsmen. Standard handle features a curved handle for spreading control and a ribbed finger grip to help prevent hand slippage. Blades are hollow-ground to provide a consistent flex and proper stiffness for spreading compounds.

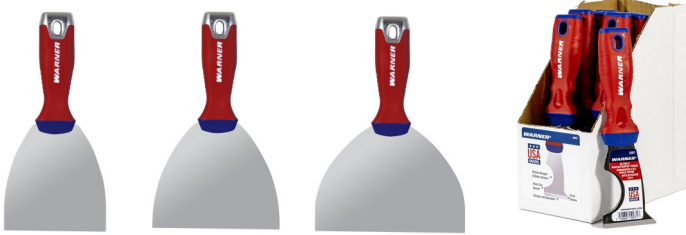

AMERICAN PRIDE SERIES

Item #	Description	Type of Packaging	Pack Weight	Pack Qty
40124	4" Flex Joint Knife, Hammer Cap™	Labeled	2	5
40125	5" Flex Joint Knife, Hammer Cap™	Labeled	2	5
40126	6" Flex Joint Knife, Hammer Cap™	Labeled	2	5
10971	5-in-1 Painter's Tool, 10/Counter Disp American Craftsman, Red, White, Blue	Boxed	3	10

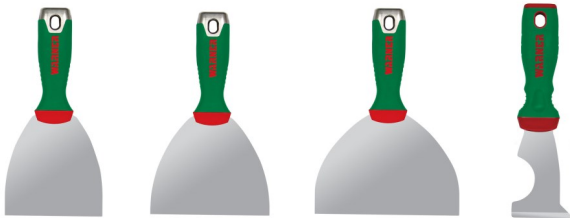

MEXICAN HERITAGE SERIES

Item #	Description	Type of Packaging	Pack Weight	Pack Qty
10144	4" Flex Joint Knife, Hammer Cap™	Labeled	2	5
10145	5" Flex Joint Knife, Hammer Cap™	Labeled	2	5
10146	6" Flex Joint Knife, Hammer Cap™	Labeled	2	5
10189	6-in-1 Painter's Tool	Labeled	2	5



MEXICAN HERITAGE SERIES—COUNTERTOP DISP

Item #	Description	Type of Packaging	Pack Weight	Pack Qty
10848	6-in-1 Painter's Tool, 10/Counter Display, #10189	Boxed	4	10

Items shaded in Blue denote Made in the USA



WARNER® STAINLESS STEEL

PRO-Stainless

All Stainless Steel hand tools are rust resistant. They have an ergonomic handle, and are easy to clean.



PRO-STAINLESS STEEL SERIES

Item #	Description	Type of Packaging	Pack Weight	Pack Qty
95108	1-1/2" Flex Putty Knife	Labeled	2	5
95114	3" Flex Putty Knife	Labeled	2	5
95124	4" Flex Joint Knife	Labeled	2	5
95126	6" Flex Joint Knife	Labeled	2	5
95173	10-in-1 Painter's Tool, Stiff	Labeled	2	5

Rosewood Series

Warner Quality— Craftsmanship You Can Trust

If you're a professional who likes the feel of wood-handled tools but wants the performance of today's technology, the choice is Warner. The Rosewood Series offers the same high-quality blades as the PROGRIP® Series, but with wood handles. Rosewood-colored handles are affixed to blades with brass coated steel rivets and eyelets. Blades are made from .050", .060", and .080" thick carbon steel.

Rosewood Series Features:

- Rosewood colored handles with brass rivet & eyelets
- Blades are made of high carbon-grade steel
- Hollow-ground, heat-treated and annealed for toughness
- Blades polished and buffed to high luster finish for easier application and cleanup
- Full-tang design for maximum strength
- Brass rivets and eyelets mechanically lock handle to tang so it cannot come loose
- Chisel-edge on stiff knives

Carbon Steel Blades

Heavy-duty blades provide maximum strength and have a chisel ground edge. Use for fine scraping and shaving with less gouging or chipping.



ROSEWOOD SERIES—STIFF— CARBON STEEL

Item #	Description	Type of Packaging	Pack Weight	Pack Qty
379	5-in-1 Painter's Tool, .080", Stiff	Labeled	3	5
601	1-1/4" Chisel Ground Putty Knife, .080", Stiff	Labeled	2	5
609	1-1/2" Stiff Putty Knife	Labeled	2	5
615	3" Stiff Scraper	Labeled	2	5



10858

Rosewood Series Display

5 of each:

379, 609, 608, 614, 622, 604, 627, 633, 637

Also see page 35



Items shaded in Blue denote Made in the USA

Carbon Steel Blades

Carbon steel blades of .050" and .060" thickness are hollow-ground to provide a flex with the proper stiffness to handle heavy drywall compounds. Use these tools for first-coat applications.



ROSEWOOD SERIES—FLEX—CARBON STEEL

Item #	Description	Type of Packaging	Pack Weight	Pack Qty
606	1-1/4" Flex Putty Knife	Labeled	2	5
608	1-1/2" Flex Putty Knife	Labeled	2	5
610	2" Flex Putty Knife	Labeled	2	5
614	3" Flex Putty Knife	Labeled	2	5
618	4" Flex Joint Knife	Labeled	2	5
620	+5" Flex Joint Knife	Labeled	2	5
622	6" Flex Joint Knife	Labeled	2	5

Carbon Steel Blades

Full flex applies to blades that have been hollow-ground thinner for maximum flexibility. They are designed for lighter compounds. Ideal for finish or final-coat applications.



ROSEWOOD SERIES—FULL FLEX—CARBON STEEL

Item #	Description	Type of Packaging	Pack Weight	Pack Qty
604	3/4" Full Flex Putty Knife	Labeled	2	5
621	1-1/4" Full Flex Putty Knife	Labeled	2	5
627	1-1/2" Full Flex Putty Knife	Labeled	2	5
628	2" Full Flex Putty Knife	Labeled	2	5
633	3" Full Flex Putty Knife	Labeled	3	5
635	4" Full Flex Joint Knife	Labeled	2	5
636	5" Full Flex Joint Knife	Labeled	2	5
637	6" Full Flex Joint Knife	Labeled	2	5

Stainless Steel Blades

Same rosewood features with high-quality stainless steel blades. Available in Stiff and Flex blade.



ROSEWOOD SERIES—STIFF—STAINLESS STEEL

Item #	Description	Type of Packaging	Pack Weight	Pack Qty
10745	5-in-1 SS Painter's Tool, .080"	Labeled	3	5
10742	1-1/4" SS Chisel Ground Putty Knife, .080"	Labeled	2	5
10750	1-1/4" SS Stiff Putty Knife	Labeled	2	5
10747	1-1/2" SS Stiff Putty Knife	Labeled	2	5
10752	2" SS Stiff Putty Knife	Labeled	2	5
10748	3" SS Stiff Scraper	Labeled	2	5

Stainless Steel Blades

Same rosewood features with high-quality stainless steel blades. Available in Stiff and Flex blade.



ROSEWOOD SERIES—FLEX—STAINLESS STEEL

Item #	Description	Type of Packaging	Pack Weight	Pack Qty
10751	1-1/4" SS Flex Putty Knife	Labeled	2	5
10753	2" SS Flex Putty Knife	Labeled	2	5
10749	3" SS Flex Putty Knife	Labeled	2	5
10740	4" SS Flex Joint Knife	Labeled	2	5
10741	6" SS Flex Joint Knife	Labeled	2	5

The Painter's Blade®, 12-in-1 Folding Knife

It's another Warner innovation—performance that you carry in your pocket. This patented tool features a carbon steel blade in a secure lockback system. It has a thumb knob for one-hand easy opening and a spring-loaded lock for closing. #10801 Folding knife is extra thin, 3/8" thick, to slide into pockets easier. The textured Aluminum handle helps prevent slippage and hand fatigue. Spring clip end. Carbon steel blade.



THE PAINTER'S BLADE® 12-in-1 FOLDING TOOL

Item #	Description	Type of Packaging	Pack Weight	Pack Qty
10801	The Painter's Blade® Folding 12-in-1	Clam	3.25	3
10847	Folding 12-in-1 Tool, 6/Counter Display, #10801	Clam in Ctr Disp	4	6

15-in-1 Painter's Tool



15-in-1 PAINTER'S TOOL

Item #	Description	Type of Packaging	Pack Weight	Pack Qty
10309	15-in-1 Painter's Tool, Hammer Cap, .080", Scraper, Spreader, Crack Cleaner, Roller Cleaner, Radius Scraper, Nail Puller, Window Putty Tool, Utility Cutter, Bottle Opener, Paint Can Opener, Nail Setter, and two screw bits: Phillips PH2; Flat #6	Labeled	2	5
10495	15-in-1 Painter's Tool, 10/Counter Display, #10309	Boxed	5	10

Items shaded in Blue denote Made in the USA



DIY Series

Rugged, hardworking line for light-duty construction or home projects. Economical tools feature blades of carbon steel for easy spreading and easy cleanup. New improved plastic polypropylene handles resist paint thinners and adhesive solvents during cleanup.



DIY SERIES—STIFF

Item #	Description	Type of Packaging	Pack Weight	Pack Qty
180	1-1/4" Stiff Putty Knife	Labeled	2	10
181	3" Stiff Scraper	Labeled	2	10
185	5-in-1 Painter's Tool	Labeled	2	10



DIY SERIES—FLEX

Item #	Description	Type of Packaging	Pack Weight	Pack Qty
182	1-1/4" Flex Putty Knife	Labeled	2	10
183	3" Flex Putty Knife	Labeled	2	10
184	4" Flex Joint Knife	Labeled	2	10
186	6" Flex Joint Knife	Labeled	2	10



DIY SERIES—FLEX

Item #	Description	Type of Packaging	Pack Weight	Pack Qty
10822	2 Pack, 1-1/4" & 3" Flex Putty Knife	Labeled	2	5
10829	3 Pack, 1-1/4", 3" & 4" Flex Putty Knives; Red, White & Blue handles	Labeled	2	10

Plastic Series

High-value, low-cost spreaders are made of tough plastic polystyrene. Made and priced to be perfect for one-time project use. Features a chisel edge to aid fine spreading or to allow light scraping on soft surfaces. Plastic tools are perfect for one-time uses such as spreading tar, adhesive, roof caulking, wood putty or other difficult to clean materials.



PLASTIC SERIES—FLEX

Item #	Description	Type of Packaging	Pack Weight	Pack Qty
902	1-1/2" Flex Plastic Putty Knife	Labeled	1	20
904	2" Flex Plastic Putty Knife	Labeled	2	20
903	3" Flex Plastic Putty Knife	Labeled	2	20
905	4" Flex Plastic Joint Knife	Labeled	2	20
901	6" Flex Plastic Joint Knife	Labeled	2	20
8150	3 Pack Plastic Putty Knives, 1 ea 2", 4" & 6"	Labeled	3	15
908	3" V-Notch Plastic Spreader, 3/16" teeth	Labeled	2	20
909	3" Square—Notch Plastic Spreader, 1/16" teeth	Labeled	2	20
11079	8" 1/8" Notched Plastic Adhesive Sp	Labeled	2	20
11080	8" Plastic Joint Knife	Labeled	2	20
11088	10" Plastic Joint Knife	Labeled	2	20

Miscellaneous Putty Knives and Scrapers

Patcher is made of tempered steel and plated for corrosion resistance. Perfect for small areas. ProCut™ Spreader is made of 35% less material and has a high carbon steel blade.



MISCELLANEOUS PUTTY KNIVES & SCRAPERS

Item #	Description	Type of Packaging	Pack Weight	Pack Qty
10824	3" V-Notch Spreader, 2 pk	Labeled	2	5

Items shaded in Blue denote Made in the USA

Painter's Series

Full-Tang, precision ground, mirror finish blade coated to prevent rust. Solvent resistant, durable plastic nylon handles. Carbon steel blades. Steel rivets and eyelets.
#502 is a stainless steel blade. Plated zinc hammer caps™ on some models.



PAINTER'S SERIES—CARBON STEEL

Item #	Description	Type of Packaging	Pack Weight	Pack Qty
10321	5-in-1 Painter's Tool, 1.2 mm = .047" thick blade, carbon steel	Labeled	1	5
11243	13-in-1 Painter's Tool	Labeled		5
502	1-1/4" Stiff Bent Putty Knife, .050", Stainless Steel	Labeled	2	5
10389	+H.D. Caulk Remover, .045", carbon steel	Labeled	2	5
11090	Painter's Series Pry Bar, w/Hammer Cap™	Labeled	2	10
11220	Painter's Series Pry Bar, 10/CounterDisp	Boxed	4	10



PAINTER'S SERIES—STIFF—CARBON STEEL

Item #	Description	Type of Packaging	Pack Weight	Pack Qty
503	3/4" Stiff Chisel Ground Putty Knife	Labeled	2	5
10328	1-1/4" Stiff Chisel Putty Knife	Labeled	1	5
11022	+1-1/4" Stiff Scraper, Hammer Cap™	Labeled	1	5
10327	1-1/2" Stiff Putty Knife	Labeled	1	5
10997	2" Stiff Scraper, Hammer Cap™	Labeled	1	10
10323	3" Stiff Scraper	Labeled	1	5



10337
Painter's Series Display
5 of each:
10320, 10327, 10322, 10323,
10324, 10326, 10321, 11090

Also see page 34



PAINTER'S SERIES—FLEX—CARBON STEEL

Item #	Description	Type of Packaging	Pack Weight	Pack Qty
504	3/4" Full Flex Putty Knife	Labeled	2	5
10320	1-1/2" Flex Putty Knife	Labeled	1	10
10322	3" Flex Putty Knife	Labeled	1	10
10324	4" Flex Joint Knife, Hammer Cap™	Labeled	1	5
10326	6" Flex Joint Knife, Hammer Cap™	Labeled	1	10
3411434	Combo Pack 1.5" Stiff and 4" Flex	Carded	4.6	10



PAINTER'S SERIES—FLEX—CARBON STEEL

Item #	Description	Type of Packaging	Pack Weight	Pack Qty
11222	8" Flex Joint Knife, Hammer Cap™	Labeled	3	5
11223	10" Flex Joint Knife, Hammer Cap™	Labeled	3	5

Perfect Pass™ Joint Knife

Revolutionary notched design makes filling drywall joints fast & easy. Tape drywall joints in 3 easy steps. Allows perfect amount of drywall compound every time. No sanding necessary. Fewer steps and less mess! The Perfect Pass™ Joint Knife has a full-tang, precision ground, and mirror finished 6" blade. Durable plastic nylon handle with Zinc alloy, chrome plated hammer cap™.



MISCELLANEOUS PUTTY KNIVES & SCRAPERS

Item #	Description	Type of Packaging	Pack Weight	Pack Qty
10832	Perfect Pass™ Joint Knife, 6"	Carded	2	5
10846	Perfect Pass™ 10/Counter Display, #10832	Boxed	4	10

The Perfect Pass™ US Patent Number **7,647,668**.

Items shaded in Blue denote Made in the USA

100X® Paint Scraper with Carbide Blades

Warner uses a special grade of tungsten carbide on 100X® Paint Scrapers because it is extremely hard and durable. In fact, the softest grade of tungsten carbide composite starts where steel stops.

Carbide 100X® Blades are diamond-ground to produce an edge sharper than steel! These blades will scrape paint faster and cleaner than any standard, hardened steel blade! That's the performance that has pushed 100X® paint scrapers to be on the "most wanted" list in the Warner line. Soft grip TPE handle includes a removable Phillips screw bit in the grip cap for changing blades. Standard handles are polypropylene. Both have an aluminum neck. The knobs are made of polypropylene and steel.



**SOFT
GRIP
HANDLE**



CARBIDE 100X® PAINT SCRAPERS

Item #	Description	Type of Packaging	Pack Weight	Pack Qty
808	22 MM (7/8") Triangle Carbide 100X® Scraper, w/o Knob, Uses # 828	Labeled	2	5
803	50 MM (2") Carbide 100X® Scraper, w/o Knob, Uses #'s 813, 819	Labeled	3	5
804	50 MM (2") Carbide 100X® Scraper, with Knob, Uses #'s 813, 819	Labeled	3	5
807	60 MM (2-3/8") Carbide 100X® Scraper, with Knob, Uses #'s 814, 816	Labeled	3	5



CARBIDE 100X® PAINT SCRAPERS-SOFT GRIP HANDLE

Item #	Description	Type of Packaging	Pack Weight	Pack Qty
10016	22 MM (7/8") Triangle Carbide 100X® Soft Grip Scraper, w/o Knob, Uses # 828	Labeled	3	5
10018	50 MM (2") Carbide 100X® Soft Grip Scraper, with Knob, Uses #'s 813, 819	Labeled	3	5
10020	60 MM (2-3/8") Carbide 100X® Soft Grip Scraper, with Knob, Uses #'s 814, 816	Labeled	3	5
3410020	60MM (2-3/8") Carbide Scraper, w/ Knob & Soft Grip Handle Uses #'s 814, 816	Labeled	3	5



CARBIDE 100X® REPLACEMENT BLADES

Item #	Description	Type of Packaging	Pack Weight	Pack Qty
828	22 MM (7/8") Triangle Carbide 100X® Blade, Card of 1, Replaces 1" triangle blade	Card	1	10
813	50 MM (2") Double Edge Carbide 100X® Blade, Card of 1	Card	1	10
819	50 MM (2") Double Edge Carbide 100X® Blades, Contractor Pack, 10/box	Contractor Pack	2	1
814	60 MM (2-3/8") Double Edge Carbide 100X® Blade, Card of 1	Card	1	10
816	60 MM (2-3/8") Double Edge Carbide 100X® Blades, Contractor Pack, 10/box	Contractor Pack	2	1

Items shaded in Blue denote Made in the USA



Affordable Scrapers and Blades

Good quality at an economical price. Ideal for light-duty home projects and more. Rugged, comfortable-to-use scrapers have plastic Polypropylene PistolGrip™ handles that arch up for proper leverage. Blades are high-carbon steel, industrial-ground, easy to replace and can be re-sharpened as needed.

Choice of two or four scraping edges depending on blade type. Multiple scraping edges require less sharpening to help get more work done in less time. #s 740, 741 & 742 are polypropylene.

2-Edge Steel Paint Scrapers & Blades



2-EDGE STEEL BLADE PAINT SCRAPERS

Item #	Description	Type of Packaging	Pack Weight	Pack Qty
742	1" Scraper, 2-Edge Blade, Uses #810	Labeled	1	5
741	2-1/2" Scraper, 2-Edge Blade, Uses #812	Labeled	2	5

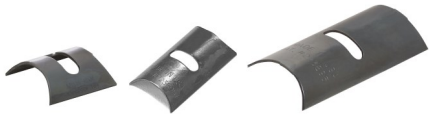

2-EDGE REPLACEMENT BLADES

Item #	Description	Type of Packaging	Pack Weight	Pack Qty
810	1" 2-Edge Blade, Card of 2	Carded	1	10
811	1-3/4" 2-Edge Blades, Card of 2	Carded	1	10
812	2-1/2" 2-Edge Blades, Card of 2	Carded	1	10

Items shaded in Blue denote Made in the USA



4-Edge Steel Paint Scrapers & Blades



4-EDGE PISTOLGRIP™ STEEL BLADE PAINT SCRAPERS

Item #	Description	Type of Packaging	Pack Weight	Pack Qty
731	1-3/4" PistolGrip™ Scraper, 4-Edge Blade, Uses #711	Labeled	1	5
708	1-3/4" PistolGrip™ Scraper with Knob, 4-Edge Blade, Uses #711	Labeled	1	5
709	2-1/2" PistolGrip™ Scraper with Knob, 4-Edge Blade, Uses #712	Labeled	1	5
34709	+2-1/2" 4-Edge Paint Scraper	Labeled	1	5

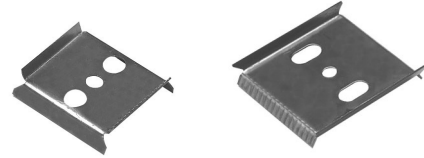

4-EDGE REPLACEMENT BLADES

Item #	Description	Type of Packaging	Pack Weight	Pack Qty
711	1-3/4" 4-Edge Blades, Card of 2	Carded	1	10
712	2-1/2" 4-Edge Blades, Card of 2	Carded	1	10

Blade Sharpening File



BLADE SHARPENING FILE

Item #	Description	Type of Packaging	Pack Weight	Pack Qty
820	Blade Sharpening File	Carded	2	10

Threaded Scrapers

Stainless Steel Threaded Scrapers attach to a choice of extension poles for overhead and hard-to-reach scraping jobs. Professional painters, maintenance crews and window cleaners use Warner pole accessories to save time and do a better job. #'s 397 & 398 handles are polypropylene with a TPE overmold. #'s 10736, 10737, 10738 & 10739 handles are ABS plastic material molded around stainless steel blade. Standard Acme Thread, 3/4"-5 x 1"



THREADED SCRAPERS

Item #	Description	Type of Packaging	Pack Weight	Pack Qty
397	3" SS Easy Reach™ Bent Scraper, Threaded Handle, .060"	Labeled	3	6
398	3" SS Easy Reach™ Scraper, Threaded Handle, .060"	Labeled	3	6
657	6" SS Easy Reach™ Bent Scraper, Threaded Handle, .060"	Labeled	2	6
10736	3" SS Straight Blade Pole Scraper, Threaded Handle	Labeled	3	6
10737	3" SS Bent Pole Scraper, Threaded Handle	Labeled	3	6
10738	4" SS Straight Blade Pole Scraper, Threaded Handle	Labeled	3	6
10739	4" SS Bent Pole Scraper, Threaded Handle	Labeled	3	6

Heavy-Duty Scrapers

Burn-off scrapers feature thick, tempered steel blades with a chisel edge. Bent blades on longer wood handles keep fingers away from surfaces or chemicals.



HEAVY DUTY BURN-OFF SCRAPERS

Item #	Description	Type of Packaging	Pack Weight	Pack Qty
387	Bent Burn-Off Scraper, Long Handle, .060", Carbon Steel Blade	Labeled	4	5
10743	3" SS Straight Burn-Off Scraper, 7-3/4" Wood Handle, replaces # 388	Labeled	2	5
10744	3" SS Bent Burn-Off Scraper, 4-1/2" Wood Handle	Labeled	2	5

Specialty Scrapers

Molding scrapers are designed for curved surfaces around windows and doors. High-carbon steel blades are industrial-ground for maximum sharpness.



UTILITY SCRAPER & REPLACEMENT BLADES

Item #	Description	Type of Packaging	Pack Weight	Pack Qty
10100	Utility Scraper with 3 Blades	Carded	3	5

Safe for scraping glass, tile, soft wood products and plastics w/o scratching the surface. Use to spread sticky & gooey compounds, they will not stick to the blade. Works great as a ice & snow scraper, safe for windshields.

Chemical Resistant Polypropylene Use with stripping chemicals

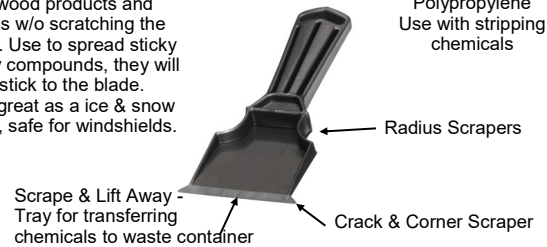

3" PLASTIC REFINISHING TOOL

Item #	Description	Type of Packaging	Pack Weight	Pack Qty
393	3" Plastic Refinishing Tool	Labeled	1	10

Items shaded in Blue denote Made in the USA



Strip 'N' Clean Scrapers for the Biggest, Toughest Jobs

Heavy-duty scrapers are made for professionals tackling big scraping jobs—from paint to floor tile. Great for removing adhesives, ceramic wall tile, asphalt tile, carpeting and various industrial applications. Featuring heavy duty scraping heads for maximum blade rigidity and handle of steel with comfortable nonslip grips. Overall length's (head and pole) shown do not include blade.



STRIP 'N' CLEAN™ SCRAPERS

Item #	Description	Type of Packaging	Pack Weight	Pack Qty
790	4" Strip 'N' Clean™ Scraper, Steel Soft Grip Handle, 10-7/8"	Carded	5	4
791	4" Strip 'N' Clean™ Scraper, Steel Handle with Rubber Grip, 16-3/4"	Carded	8	4
792	4" Strip 'N' Clean™ Floor Scraper, Steel Handle, 48"	Carded	15	4
10419	10" Heavy Duty Floor Scraper, Steel Handle, 52-1/8" Uses #10423 Blade	Carded	9	2
BD10360	Bull Dog™ 6" Heavy Duty Floor Scraper, Steel Handle, 53-7/8" Uses #794 Blade	Carded	14	2

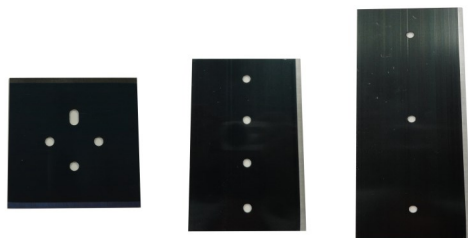

STRIP 'N' CLEAN™ REPLACEMENT BLADES

Item #	Description	Type of Packaging	Pack Weight	Pack Qty
793	4" Strip 'N' Clean™ Scraper, Rplcmt Blade, Blue Steel, Double Edge	Carded	2	5
794	6" Strip 'N' Clean™ Scraper, Rplcmt Blade, Blue Steel, Single Edge	Carded	3	5
10423	10" Heavy Duty Rplcmt Blade, Ground Hardened Steel Blade, .Single Edge, .050" For #10419	Carded	4	5

Items shaded in Blue denote Made in the USA



4", 5", and 6" Scrapers

Industrial-ground carbon steel blades and big, beefy scrapers can take on practically any scraping job. Tools are designed to deliver maximum leverage on wall and floor surfaces. Multipurpose scrapers tackle anything from wax buildup to dried adhesives. Scraper #690 is a popular tool used in a wide variety of industries. #34690 has a polypropylene with a soft TPR over-mold threaded handle. Scrapers are packaged with the blunt edge of the blade exposed for safety, reverse the blade to expose the sharp edge. Overall length's (head and pole) shown do not include blade. Standard Acme Thread, 3/4"-5 x 1" on 34690 and 11221.



BIG BLADE SCRAPERS

Item #	Description	Type of Packaging	Pack Weight	Pack Qty
34690	4" Paint-Wall-Floor Scraper, 11-3/8" Steel Handle w/ Threaded Soft Grip Uses #'s 695, 698, 699	Carded	6	10
691	4" Wall Scraper, Steel Handle, 7" Uses #'s 695, 698 & 699	Carded	4	10
11221	6" H.D. Paint & Wall Scraper, 24" Steel Handle with Threaded Soft Grip Uses # 11225	Carded	5	6
693	4" Floor Scraper, Steel Handle, 50-9/16" Uses #'s 695, 698 & 699	Carded	10	5
591	5" Heavy Duty Floor Scraper, Steel Handle, 47-1/4" Uses #'s 595 & 599	Carded	10	5

Replacement Blades

The #695 & #699 are .02" x .56" x 4". The #595 & #599 are The #11225 are

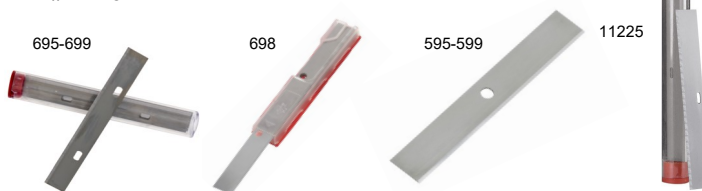

BIG BLADE REPLACEMENT

Item #	Description	Type of Packaging	Pack Weight	Pack Qty
695	4" Wall Scraper, Rplcmt Blades, Card of 5 (double hole) For #'s 690, 34690, 691, 693, 10907 & 10908	Carded	1	10
698	4" Wall Scraper, Rplcmt Blades Dispenser, Carton of 100, 10 Dispenser of 10 Blades (single hole) For #'s 34690, 691 & 693	Carded	2	10
699	4" Wall Scraper, Rplcmt Blades, 100 Bulk (double hole) For #'s 690, 34690, 691, 693, 10907 & 10908	Bulk	2	1
595	5" Heavy Duty Scraper, Rplcmt Blades, Card of 5 For #'s 590 & 591	Carded	2	10
599	5" Heavy Duty Scraper, Rplcmt Blades, 50 Bulk For #'s 590 & 591	Bulk	2	1
11225	6" H.D. Replacement Blade, 5 Blades/ Tube, For #11221	Carded	1.2	10

Glass Scrapers

All of the Safety 1st™ scrapers in the Warner line have been designed to minimize risk with quick and convenient blade-changing features. Warner is the only company with all safety-style blade-changing systems. Use for a variety of light-duty scraping jobs, including scraping paint and decals off windows. #s 100 & 356 are made of polystyrene.



SAFETY 1ST™ SCRAPERS

Item #	Description	Type of Packaging	Pack Weight	Pack Qty
356	Safety 1st™ Utility Scraper, with 1 Blade, Uses #s 360	Carded	2	10
10500	Soft Grip Safety 1st™ Scraper, with 1 Single Edge Blade, Uses #s 102, 109, 34129	Carded	2	10
11500	Soft grip Safety Scraper, with 5 Blades Uses #s 102, 109, 34129	Carded	2	10

Razor Scrapers

Blade holders have convenient blade storage in the handle.



MINI RAZOR SCRAPERS

Item #	Description	Type of Packaging	Pack Weight	Pack Qty
34114	Mini Glass Scraper/Blade Holder with 2 Blades, Carded	Carded	1	20
101	Mini Glass Scraper/Blade Holder with 2 Blades, 25/Bucket	Bagged in Bucket	2	25
102395	Mini Glass Scraper/Blade Holder with 2 Blades, Bagged, 25/Box	Bagged in Box	1	25
10908	Glass & Tile Scraper Set, Uses # 11314, 695 & 699	Carded/Blistered	1	10
10907	4" Glass & Tile Scraper, w/ 2 Blades, Uses # 11314, 695 & 699	Carded/Blistered	1	10

Single Edge Blades

Single-edge blades are made to Warner's industrial specifications of high-carbon steel, .009" & .012" thick. Blades are ground, honed and tempered for durability.



SINGLE EDGE RAZOR & GLASS SCRAPER BLADES

Item #	Description	Type of Packaging	Pack Weight	Pack Qty
34129	10 Single Edge Razor Blades in Dispenser, .009", For #s 101, 114, 429, 490, 10300, 10500	Carded	2	10
109	Single Edge Razor Blades, .009", 100/Tub, Steel Back, 10 Tubs/ Counter Display, For #s 101, 114, 429, 490, 10300, 10500	Tub or Clamshell	1	10
102	Bucket of Blades, 5 Pack Tuck, Bucket of 50 Tucks, .009", For #s 101, 114, 429, 490, 10300, 10500	Tucks in Bucket	5	50
11163	+50 Pack Single Edge Razor Blades in Safety Dispenser, 50 Blades/Dispenser, 6 Dispensers/Box	Dispenser		6
11314	+4" Glass & Tile Replacement Blades, (double hole) For #s 10907 & 10908	Carded		10



All utility blades are carbon steel

UTILITY BLADES

Item #	Description	Type of Packaging	Pack Weight	Pack Qty
360	H.D. Utility Blades, .025", Card of 5, (2 Notches & Ctr Hole) For #s 352, 356, 366, 566, 1052, 11181, 11185, 11187	Carded	1	10
10807	+Utility Blades, .025", 50 in Plastic Dispenser, (2 Notches) For #s 352, 366, 566, 1052, 11181, 11185, 11187	Carded	7	12
10808	Utility Blades, .025", 100 in Plastic Dispenser, (2 Notches) For #s 352, 366, 566, 1052, 11181, 11185, 11187	Carded	12	12
11049	100 H.D. Utility Blades, .025", 20 individual 5 packs, (2 Notches) For #s 352, 366, 566, 1052, 11181, 11185, 11187	Boxed	1	1 ctn

Snap-Off Blade Knives

Snap-off blade knives with multiple cutting edges and locking thumb advance mechanism for a fresh sharp blade. Just snap-off the old blade to expose a fresh, sharp edge. Replacement blades are carbon steel.



SNAP-OFF BLADE KNIVES

Item #	Description	Type of Packaging	Pack Weight	Pack Qty
117	13 Point 9MM Ergo Snap-Off Blade Knife with 1 Blade, Uses #'s 116 & 10806	Carded	2	10
119	8 Point 18MM Ergo Snap-Off Blade Knife with 3 Blades, Uses #'s 120 & 10805	Carded	3	10
10841	13 Point 9MM Auto-Retract Knife Snap-Off Blade Knife with 1 Blade, Uses #'s 116 & 10806	Carded	3	10
10798	8 Point 18MM Economy Snap-Off Blade Knife with 1 Blade, Uses #'s 120 & 10805	Bagged in Bucket	2	25
102380	8 Point 18MM Economy Snap-Off Blade Knife with 1 Blade, Uses #'s 120 & 10805	Bagged in Box	2	25
10799	13 Point 9MM Economy Snap-Off Blade Knife with 1 Blade, Uses #'s 116 & 10806	Bagged In Bucket	2	50
102381	13 Point 9MM Economy Snap-Off Blade Knife with 1 Blade, Uses #'s 116 & 10806	Bagged in Box	2	50



SNAP-OFF BLADE KNIFE BLADES

Item #	Description	Type of Packaging	Pack Weight	Pack Qty
120	8 Point 18MM Snap-Off Rplcmt Blades, Card of 5	Carded	1	10
116	13 Point 9MM Snap-Off Rplcmt Blades, Card of 5	Carded	1	10
10805	+8 Point 18MM Snap-Off Blades, 50 in a Plastic Tube on Blister Card	Carded	4	6
10806	13 Point 9MM Snap-Off Blades, 50 in a Plastic Tube on Blister Card	Carded	2	6

Utility Knives

Utility knives feature heavy-duty, die-cast zinc, aluminum or plastic housings with ground and honed high-carbon steel blades. Top trigger release designs allow blade to be retracted for safety. The fixed blade version securely clamps the blade in a cutting position. The folding utility knife folds for safety and convenience. Pivot blade open with one hand using thumb pin. To change blade, push button and pull blade forward. A special safety feature of the #566 safety utility knife is a spring-loaded, self-retracting blade. Pressing the trigger exposes the blade, and the blade retracts when the trigger is released.



UTILITY KNIVES

Item #	Description	Type of Packaging	Pack Weight	Pack Qty
366	Top Trigger Utility Knife, with 3 Blades Uses #'s 360, 10807, 10808, 10809, 11049	Carded	4	10
566	Safety 1st™ Self-Retracting Utility Knife, with 1 Blade Uses #'s 360, 10807, 10808, 10809, 11049	Carded	4	10
11185	Folding & Locking Zinc Utility Knife, w/1 Blade, 10/Counter Disp Uses #'s 360, 10807, 10808, 10809, 11049	Carded	5.5	10
11187	Folding & Locking Plastic Utility Knife, w/6 Blades, 10/Counter Disp Uses #'s 360, 10807, 10808, 10809, 11049	Carded	5.8	10

Items shaded in Blue denote Made in the USA



Extension Poles

Handy extension poles #'s 145 & 262 are made of tough steel tubing and are an excellent value. End-Cap adapter is nylon and fits standard 3/4" thread accessories. Twist lock secures adjustable poles at any point out to full extension. #10836 is Aluminum.



STEEL POLES

Item #	Description	Type of Packaging	Pack Weight	Pack Qty
262	Steel Extension Pole 4' - 6.5', Male Treaded, Twist Lock (48"-78")	Labeled	12	10

Hopper Gun

Ideal for spraying walls and ceilings, the hopper gun includes three nozzles, air shutoff valve, and 1/4" quick disconnect. Made of lightweight aluminum with 1-3/4" gallon capacity, internal brass components, and comfortable, full-length grip trigger. Angled boot for ceiling spraying. Tips sizes included: 3/16", 1/4", 5/16".

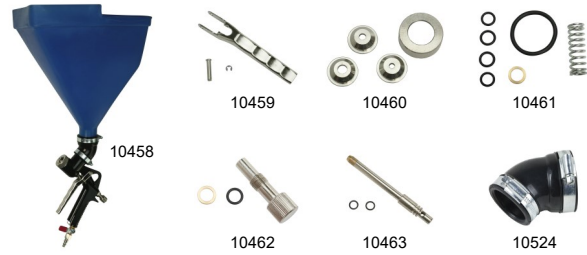

HOPPER GUN

Item #	Description	Type of Packaging	Pack Weight	Pack Qty
10458	Hopper Gun	Boxed	1	1
10459	Replacement Handle, Pin & Clip	Bagged	1	1
10460	Replacement Nozzles & Retaining Ring	Bagged	1	1
10461	O Ring Replacement Kit	Bagged	1	1
10462	Adjustable Knob Assembly	Bagged	1	1
10463	Replacement Gun Needle Kit	Bagged	1	1
10524	45° Flexible Hopper Boot, with 2 Clamps	Bagged	1	1

Pliers, Screwdriver & Tape Measure

6" Long Nose Pliers, 6-in-1 Screwdriver, and 16' Tape Measure. The pliers have grooved jaws for slip resistant grip, forged steel construction and soft-grip handles. The Screwdriver includes 4 bits and 2 nut drivers, ball lock tips and solid high visibility orange handle. The tape measure has a plastic case, strap and metal 16' tape.



PLIERS, SCREWDRIVER & TAPE MEASURE

Item #	Description	Type of Packaging	Pack Weight	Pack Qty
10838	6" Long Nose Pliers	Labeled	4	10
10839	6-in-1 Screwdriver	Labeled	3	10
10840	16' Tape Measure	Labeled	5	10

Paint Test Set, Sheets and Panel

Easily take sheet or panel from room to room. Compare colors for matching carpet, furniture and accessories and view in different lighting. Test and toss or save for future use. Paint on dull/matte side of sheet/panel.

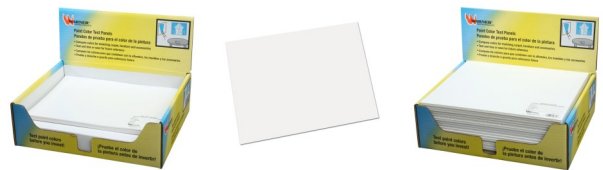

PAINT TEST SET, SHEETS AND PANEL

Item #	Description	Type of Packaging	Pack Weight	Pack Qty
10628	12" x 9" Polystyrene Paint Color Test Sheet	Boxed	2	20
10629	18" x 24" Polystyrene Paint Color Test Sheet	Boxed	7	20
10630	12" x 9" Foam Board Paint Color Test Panel	Boxed	3	20

Items shaded in Blue denote Made in the USA



Spray Shields

Spray shields provide protection when painting or finishing. They are lightweight to minimize fatigue and are easy to clean. Pivoting Handle Spray Shields have a 12" handle on the 24" blade and an 18" handle on the 36" or 48" blade. Handle pivots out of the way for storage and transportation. Also handle can pivot to adjust the angle to reach into corners. The blades are 9" deep including the plastic back plate. Approximately 7 5/8" exposed blade. The #10179 is 10" x 31". Standard Acme Thread, 3/4"-5 x 1"

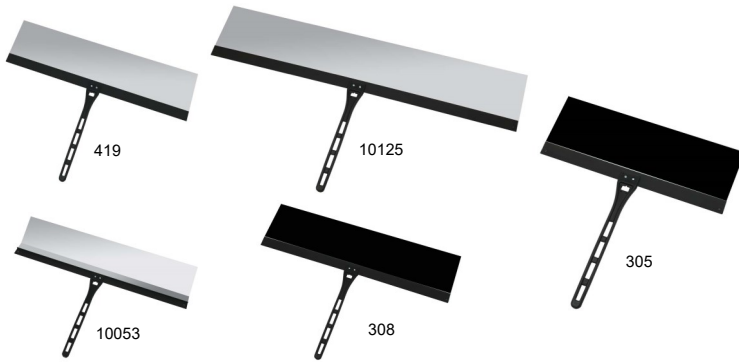

ALUMINUM SPRAY SHIELDS ADJUSTABLE HANDLE

Item #	Description	Type of Packaging	Pack Weight	Pack Qty
10050	36" Aluminum Spray Shield, Adj. Swivel Head, with 18" Wood Handle	Labeled	10	5

ALUMINUM SPRAY SHIELDS, PIVOT HANDLE

Item #	Description	Type of Packaging	Pack Weight	Pack Qty
419	36" Aluminum Spray Shield, 18" Plastic Pivot Handle	Labeled	3	5
10125	48" Aluminum Spray Shield, 18" Plastic Pivot Handle	Labeled	8	5
10053	36" Bent Aluminum Spray Shield, 18" Plastic Pivot Handle	Labeled	8	5



SHIELD HOLDER & CARDBOARD

Item #	Description	Type of Packaging	Pack Weight	Pack Qty
10187	Plastic Spray Shield Holder, Standard Acme Thread, 3/4"-5 x 1"	Labeled	4	5
10179	31" Cardboard for Spray Shield 10" x 31"	Labeled	12	50
11362	Cardboard Spray Shield Holder w/ Pole. Standard Acme Thread, 3/4"-5 x 1"	Labeled	4	5

PLASTIC SPRAY SHIELDS, PIVOT HANDLE

Item #	Description	Type of Packaging	Pack Weight	Pack Qty
305	24" Plastic Spray Shield, 12" Plastic Pivot Handle	Labeled	6	5
308	36" Plastic Spray Shield, 12" Plastic Pivot Handle	Labeled	9	5

Miscellaneous Paint Accessories

MISCELLANEOUS PAINT ACCESSORIES

Item #	Description	Type of Packaging	Pack Weight	Pack Qty
138	Glass Cutter	Carded	1	10
142	Glazier Push Points, Size #7, Carded, Approx. 50	Carded	1	10
395	Double Ended Window Tool, S.S., Full Tang Blade	Carded	2	5
411	Swivel Pot Hook	Carded	2	10
412	Handy Pot Hooks, Card of 2	Carded	2	10
10031	Super Soft Knee Pads	Labeled	8	6 pair
34016	Graining Tool, 4/CC	Carded	2	4
10263	Brush Extension, Standard Acme Thread, 3/4"-5 x 1"	Carded	4	2
10831	5 Gallon Wood Paint Paddle, 21"	Labeled	31	250
11215	Paint Project Lifters, 8/Card, 6 Cards/Box	Carded	1.2	6

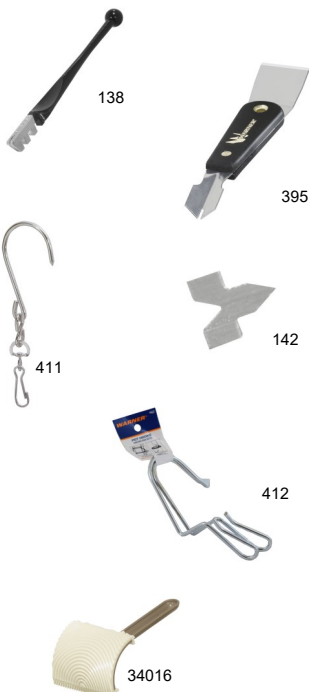

Items shaded in Blue denote Made in the USA

Paint and Trim Guides

Thin, flat paint guides help give you a perfect edge. They protect molding, trim and non-painted surfaces from spatter and over-painting. #'s 428 & 433 have a S.S. blade. #431 is polystyrene. #'s 432 & 434 have aluminum handle & coated steel blade.

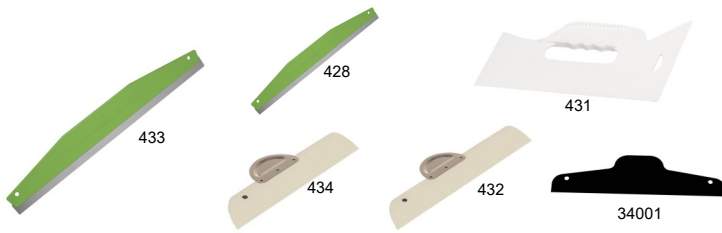

PAINT & TRIM GUIDES

Item #	Description	Type of Packaging	Pack Weight	Pack Qty
428	12" Paint Guide	Labeled	3	10
433	23" Paint Guide & Wallcovering Tool	Labeled	6	10
431	Triple Edge Guide	Labeled	3	10
434	10" Paint Guide	Labeled	2	20
432	15" Paint Guide	Labeled	2	20
34001	+12" Plastic Paint Guide, 30/CC	Labeled	2	30

Pry Bars

Rugged tools help remove molding and trim fast and easy. Every toolbox needs one of these pry bars.



PRY BARS

Item #	Description	Type of Packaging	Pack Weight	Pack Qty
10350	Painter's Pry Bar	Labeled	4	5
11090	Painter's Series Pry Bar, W/ Ham Ca	Labeled	2	10

Bucket Openers



BUCKET OPENERS

Item #	Description	Type of Packaging	Pack Weight	Pack Qty
556	Plastic Pail Opener	Cut Ctn	3	5
144	Aluminum Lid Cutter/Closer/Opener	Labeled	4	5
10000	Paint Can Opener, 2 per Label	Carded	1	10
260	Wire Paint Can Opener, 100 Bulk	Boxed	10	100
261	Wire Paint Can Opener, 100/Bucket	Bucket	10	100

Mixers

Use heavy-duty mixing blades for paint, drywall compound, adhesive, driveway coatings and other viscous materials. All have steel shafts for 1/2" or 3/8" drills. Mixer heads reach to the bottom of the bucket.

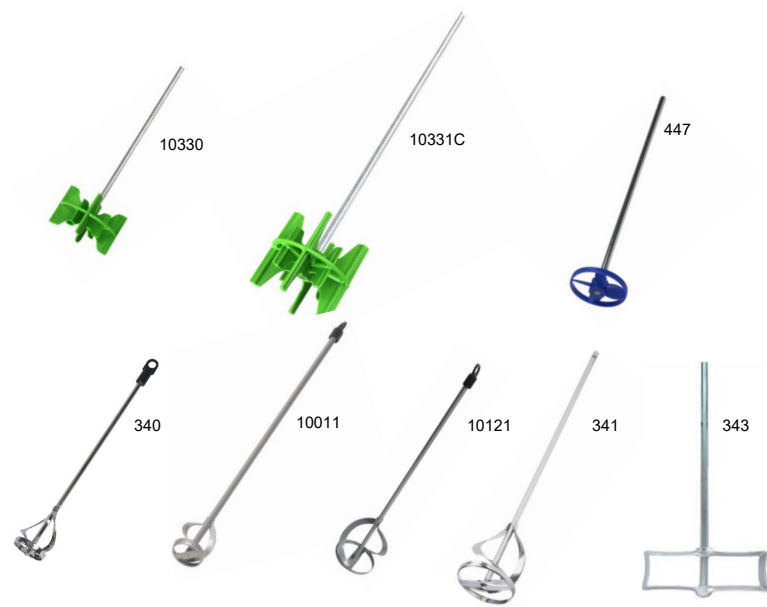

MIXERS

Item #	Description	Type of Packaging	Pack Weight	Pack Qty
10330	1 Gallon Plastic Paint Mixer, 10"	Labeled	1	6
10331C	5 Gallon Plastic Paint Mixer, 18" Hang Cap in Carton	Labeled	3	6
447	1 Gallon 2" Plastic Paint Mixer, 9" Long Round Metal Shaft, 3/8" Drill	Labeled	3	10
340	1 Gallon Paint Mixer, 2-3/8" Spiral Blades, Heavy Duty, 15-3/4" Long Hex Shaft, 3/8" Drill	labeled	10	6
10011	1-5 Gallon Paint/Epoxy 1-3/4" Spiral Mixer, 18-3/4" Long Hex Shaft, 3/8" Drill	Labeled	4	6
10121	5 Gallon 3-1/4" Spiral Paint Mixer, 15-3/4" Long Shaft, 3/8" Drill	Cut Carton	4	6
341	5 Gallon Paint Mixer, 4" Spiral Blades, Heavy Duty, 22-3/4" Long Hex Shaft, 1/2" Drill	Labeled	16	6
343	Heavy Duty Compound Mixer, 30" Long Hex Shaft, 3/8" Drill	Labeled	10.5	6



STRAINER BAG SQUEEGEE AND PAIL SCOOP

Item #	Description	Type of Packaging	Pack Weight	Pack Qty
11269	Strainer Bag Squeegee w/ Pail Scoop	Labeled	1.5	10

Plastic Buckets & Can Clip

A variety of buckets for all maintenance and construction projects. Economical buckets make work go faster and cleanup easier. #543 has a .070 wall thickness.



BUCKETS

Item #	Description	Type of Packaging	Pack Weight	Pack Qty
543	+5 Gallon Plastic Bucket	Labeled	20	10
10056	5 Quart Measuring Container	Labeled	8	100
10059	5 Quart Container Lid	Labeled	3	50
11093	3-in-1 Paint Can Clip, 16/CC	Cut Carton	2.02	16
11094	3-in-1 Paint Can Clip, 15/Bucket	Labeled	2	15

Paint Grid and Roller Trays



PAINT GRID AND ROLLER TRAYS

Item #	Description	Type of Packaging	Pack Weight	Pack Qty
11085	5-Gallon Metal Paint Grid	Labeled	5.5	12
11086	+9" Roller Plastic Paint Tray, Deep well	Labeled	5.8	6

Brush & Roller Cleaners



BRUSH & ROLLER CLEANERS

Item #	Description	Type of Packaging	Pack Weight	Pack Qty
269	Brush Comb & Roller Cleaner	Carded	2	10
279	Brush & Roller Cleaner	Carded	2	12
380	Roller-Brush Cleaner	Carded	8	4

1 Gallon Paint Can Lid and Pour Spout

The Warner 1 Gallon Paint Can Lid with Pour Spout works with Metal Rimmed, and Plastic Rimmed 1 Gallon Cans. Triple Sealed – The unique design seals against the outside of the can, the inside of the can, and also the rim groove to eliminate drops and keeps the rim clean for reusing the paint can lid for long term storage. For use with all water-based paints and stains. Easy to clean and is reusable. See NPB for more information.



1 GALLON PAINT CAN LID AND POUR SPOUT

Item #	Description	Type of Packaging	Pack Wt	Pack Qty
20640	1 Gallon Paint Can Lid and Pour Spout	Carded	1.12	6

Paint Tote

The 3-in-1 Paint Tote has double handles that provide stability for holding in one hand when loading roller, brushes and transporting. The comfortable ergonomic grip area built into the bottom of the tote to hold the bucket comfortably in the palm of your hand. The rotating roller tray can be stored out of the way when not in use. A thin disposable liner is available to avoid cleanup. Top dimensions: 5.25" x 7.25", bottom dimension: 4" x 6", tray dimension: 5.75" long x 5.375" wide. Hold 1 quart or 1/4 gallon. Paint Tote is polypropylene. Liner is PETE (Polyethylene terephthalate).



3-IN-1 PAINT TOTE

Item #	Description	Type of Packaging	Pack Weight	Pack Qty
20630	+3-in-1 Paint Tote	Labeled	4	4
20631	+Transparent Replacement Liners, 5 each 3-packs for a total of 15 liners	Labeled	2	5

3-in-1 Paint Tote™ US Patent Number **10,086,977**.

1-Gallon Paint Can Carrier

Attaches to your can in seconds. Hook bail & hook rim. Paint from the can. Less mess, quicker clean up. Built in ladder hook. Magnetic paintbrush holder. Offset handle makes it easy to get brush in and out of can.



PAINT CAN CARRIER WITH MAGNET & OPENER

Item #	Description	Type of Packaging	Pack Weight	Pack Qty
11104	Paint Can Carrier with Magnet & Opener	Carded	3.5	6

Items shaded in Blue denote Made in the USA



Soft Grip Wire Brushes

Wire brushes remove rust, scale and flaking paint. Also for roughing smooth surfaces before applying adhesives. Our wire brushes are either high carbon steel, stainless steel, nylon, or brass. The handles are made of polypropylene and thermoplastic rubber (TPR).



Wood Handle Wire Brushes

Wire brushes remove rust, scale and flaking paint. Also for roughing smooth surfaces before applying adhesives. Our wood handle wire brushes are 1070 steel. The handles are made of Schima wood. The scraper is zinc plated steel.



SOFT GRIP WIRE BRUSHES

Item #	Description	Type of Packaging	Pack Weight	Pack Qty
10481	Soft Grip Mini Brush Set Bagged	Labeled	3	12
10483	Soft Grip 14" Stainless Wire Brush with Scraper, 3x13 row	Labeled	3	6
10485	Soft Grip 12" Steel Wire Brush with Scraper, 4x11 row	Labeled	4	6
10486	Soft Grip 10" Steel Shoe Handle Wire Brush, 4x16 row	Labeled	3	6
11123	+3-Pack MULTI Mini Brush Set; 1 each SS, Brass and Nylon Brush	Reusable Holder	3	12
11125	+3-Pack STAINLESS STEEL Mini Brush Set	Reusable Holder	3	12
11159	3-in-1 Caulk Tool	Carded	2	10
11160	2-in-1 Painter's Brush, Steel Bristle, 1.75" 4-Edge Scraper, 6x10 row	Labeled	3	6
11397	Long Handled Scrubbing Brush, Labeled	Cut Carton	4	8
11400	3-Pack Multi Mini Brush Set, wrap hanging card		2.5	12
11412	3-Pack SS Mini Brush Set, wrap hanging card		2.6	12
3410108	3-IN-1 Stripping Brush	Carded	2	10
3410482	Soft Grip 14" Steel Wire Brush with Scraper, 3x13 row	Labeled	3	6
3410486	10.25" Steel Shoe Handle Wire Brush 4x16 row, Labeled	Labeled	3.6	8
3410491	Soft Grip Nylon Stripper Brush, 5x11 row, Labeled	Cut Carton	1.9	12
3410492	Soft Grip Wide Brass Stripper Brush 5x11 row	Labeled	1.7	12
3410493	Soft Grip Stainless Steel Stripper Brush, 5x11 row, Labeled	Labeled	2.3	12
3410487	Steel Wire Scrub Brush w/ Scraper, Threaded, row	Labeled	5.4	8

WOOD HANDLE WIRE BRUSHES

Item #	Description	Type of Packaging	Pack Weight	Pack Qty
11081	Wood Handle 13-5/8" Steel Wire Brush w/Scraper, 3x19 row	Labeled	3	12
11082	Wood Handle 13-5/8" Steel Wire Brush, 3x19 row	Labeled	3.25	12
11083	Wood Handle 10" Steel Wire Brush w/Scraper, 4x16 row	Labeled	4.5	12
11084	Wood Handle 10" Steel Wire Brush, 4x16 row	Labeled	4	12
11462	Wood Handle 10" Steel Wire Brush w/Scraper, 4x11 row	Labeled	3	6
11463	Wood Handle 10" Steel Wire Brush w/ Scraper, 4x16 row	Labeled	2.5	6
11464	Wood Scrub Brush, Steel Wire, Threaded, 6x19 row	Labeled	3.2	6
11469	Wood Handle 10" S.S. Wire Brush, 4x16 row	Labeled	2.4	6
11471	Wood Handle 13" S.S. Wire Brush, 3x19 row	Labeled	2.5	6



PLASTIC HANDLE WIRE BRUSHES

Item #	Description	Type of Packaging	Pack Weight	Pack Qty
572	Mini Brush Set, 3 Piece: S.S., Brass & Nylon	Bagged	2	12
10024	Brass Mini Brush, 2 Pack	Bagged	1	24

Strap-N-Stride™ Aluminum Stilts

Lightweight stilts are perfect for handling walls and overheads where scaffolding and ladders are inconvenient. Strap-N-Stride™ Adjustable stilts adjust quickly and easily without tools, featuring dual-action spring action to make walking more natural. Stilts have cotton straps with heavy-duty spring clips on the toe and calf. Permanently installed at the factory to prevent accidental loss. Other features include wider adjustable sole and heel plates with wider rubber sole bottoms for stability. Instruction manual included. Weight limit of 230 lbs with tools. #10770 has 7 holes. #10771 has 9 holes.



STRAP-N-STRIDE™ ALUMINUM STILTS

Item #	Description	Type of Packaging	Pack Weight	Pack Qty
10770	Strap-N-Stride™ Aluminum Stilts 18"-30"	Boxed	16	1 pair
10771	Strap-N-Stride™ Aluminum Stilts 24"-40"	Boxed	18.25	1 pair

STRAP-N-STRIDE™ STILT REPLACEMENT PARTS

Item #	Description	Type of Packaging	Pack Weight	Pack Qty
10233	Side Pole Kit 18" - 30", for #10770	Bagged	2	1 kit
10232	Side Pole Kit 24" - 40", for #10771	Bagged	3	1 kit
10239	Upper Side Pole Clamping Kit	Bagged	1	1 kit
6473	Spring Kit	Bagged	1	1 kit
10783	Bolts/Bearing Overhaul Kit	Bagged	1	1 kit
7090	Nylon Bushing Kit	Bagged	1	1 kit
6476	Wing Bolt Kit	Bagged	1	1 kit
10238	Leg Support Cuff Kit	Bagged	1	1 kit
10775	Heel Cup Kit	Bagged	1	1 kit
10776	Strap Kit* All Straps/Pads for a pair	Bagged	1	1 kit
10773	Foot/Floor Plate Kit	Bagged	1	1 kit
10774	Floor Pad Kit	Bagged	2	1 kit
10812	Toe Strap Kit	Bagged	1	1 kit
10813	Ankle Strap and Buckle Kit, for 1 stilt	Bagged	1	1 kit
10814	Ankle Strap Pad Kit	Bagged	1	1 kit
10815	Calf Strap Kit	Bagged	1	1 kit



Read and follow any safety related information in or on the product and packaging

CALL WARNER CUSTOMER SERVICE FOR PARTS LISTS @ 800-444-0606

*90-Day Limited Warranty. See www.warnertool.com or call 800-444-0606 for details.

EZ-Stride® Step-Up Benches

EZ-Stride® Step-Up Benches are made of lightweight, extruded, high-strength aluminum. They set up quickly and easily and are available in four sizes, 24", 29", 35" and 46". They fit in small, tight areas and are easy to transport. They hold up to 300 lbs with tools. Assembly tools are included. The bench top is 9-1/2" wide and 28" long.

EZ-STRIDE® STEP-UP BENCHES

Item #	Description	Type of Packaging	Pack Weight	Pack Qty
10225	EZ-Stride® Step-up Bench 24"	Boxed	27	2
10227	EZ-Stride® Step-up Bench 35"	Boxed	40	2



10225



10227



10296



10297

10298



10314

EZ-STRIDE® STEP-UP BENCH REPLACEMENT PARTS

Item #	Description	Type of Packaging	Pack Weight	Pack Qty
10296	Foot Pad Kit for #10225, #10226, #10227 & #10228, #10862, #10863, #10864, #10865	Bagged	1	1
10297	24" & 29" Spreader Bar Kit for #10225 & #10226, #10862 & #10863	Bagged	1	1
10298	35" & 46" Spreader Bar Kit for #10227 & #10228, #10864 & #10865	Bagged	1	1
10314	Hinge Kit for #10225, #10226, #10227 & #10228, #10862, #10863, #10864, #10865	Boxed	1	1
11487	Label set for #10225 Step-Up Bench		1	1 set
11488	Label set for #10226 Step-Up Bench		1	1 set
11489	Label set for #10227 Step-Up Bench		1	1 set
11490	Label set for #10228 Step-Up Bench		1	1 set

****Read and follow any safety related information in or on the product and packaging****

CALL WARNER CUSTOMER SERVICE FOR PARTS LISTS @ 800-444-0606

*90-Day Limited Warranty. See www.warnertool.com or call 800-444-0606 for details.

EZ-Stride® Drywall Bench

The EZ-Stride® Folding Drywall Bench is made out of lightweight, extruded aircraft aluminum with heavy-duty welds, and it holds up to 450 lbs with tools. Bench top measures 9-1/2" wide and 48" long, providing ample room for working. The height adjusts from 18" to 28". The bench folds to 6-1/2" x 16" x 48" and weighs just 36 lbs.



EZ-STRIDE® DRYWALL BENCH

Item #	Description	Type of Packaging	Pack Weight	Pack Qty
10329	EZ-Stride® Drywall Bench	Boxed	36	1



EZ-STRIDE® DRYWALL BENCH REPLACEMENT PARTS

Item #	Description	Type of Packaging	Pack Weight	Pack Qty
10160	Replacement Extension Leg Braces/ Steps for #10040, 2 ea	Boxed	3	1
10127	Replacement Rubber Foot Pads, 4 ea, for #10329	Bagged	1	1
10090	Replacement Leg with Rubber Pad Attached, 1 ea, for #10329	Bagged	2	1
10345	Replacement Step, 1 ea, for #10329 with Bolts & Rollers	Boxed	5	1
10634	Safety Locking Collar, 2/bag, for #10329	Bagged	.5	1
10843	Adj. Handle Assembly, for #10329	Boxed	1.15	1
10844	Folding Hinge Assembly, for #10329	Boxed	1	1
10845	A Frame Leg Holder, for #10329	Boxed	1	1

10843



10844

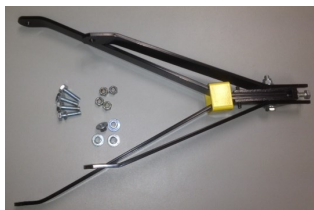

10634



10845



****Read and follow any safety related information in or on the product and packaging****

CALL WARNER CUSTOMER SERVICE FOR PARTS LISTS @ 800-444-0606

*90-Day Limited Warranty. See www.warnertool.com or call 800-444-0606 for details.

Taping Knives

Offering a range of taping knives, typically 6" and 8" knives are used for setting tape and 10" and 12" blades are used for applying finish coats. Blades are supported with aluminum backings.

PROGRIP® Blue Steel & Stainless Steel

The PROGRIP® line of taping knives features soft grip, ergonomic handles with blue steel or stainless steel blades. The handles are polypropylene with a TPE (Thermoplastic Elastomer) overmold. Aluminum back plates. Handles are riveted to blades.

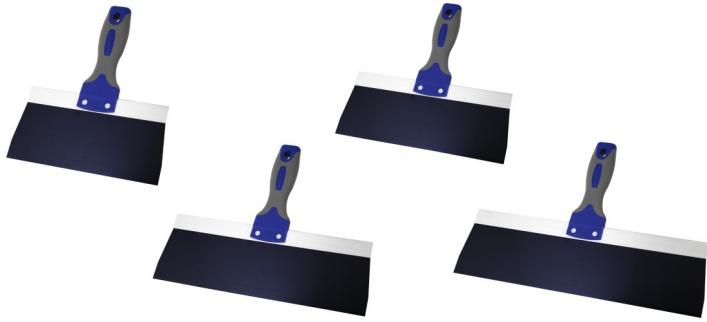

Professional Aluminum Backing Plate

Aluminum backing provides blade rigidity while making these knives up to 40% lighter than standard taping knives. Polypropylene handle is molded to the extruded aluminum backing plate so it cannot come loose. Blade flares out at edges to reach into corners. Blue steel or stainless steel blades.



PROGRIP® - BLUE STEEL TAPING KNIVES

Item #	Description	Type of Packaging	Pack Weight	Pack Qty
10871	PROGRIP® 8" Soft Grip Taping Knife, Blue Steel	Labeled	4	5
10872	PROGRIP® 10" Soft Grip Taping Knife, Blue Steel	Labeled	4	5
10873	PROGRIP® 12" Soft Grip Taping Knife, Blue Steel	Labeled	4	5
10879	PROGRIP® 14" Soft Grip Taping Knife, Blue Steel	Labeled	4	5

BLUE STEEL TAPING KNIVES, PLASTIC HANDLE

Item #	Description	Type of Packaging	Pack Weight	Pack Qty
746	6" Taping Knife, Plastic Handle, Blue Steel	Labeled	2	5
748	8" Taping Knife, Plastic Handle, Blue Steel	Labeled	2	5
750	10" Taping Knife, Plastic Handle, Blue Steel	Labeled	3	5
752	12" Taping Knife, Plastic Handle, Blue Steel	Labeled	3	5



PROGRIP® - STAINLESS STEEL TAPING KNIVES

Item #	Description	Type of Packaging	Pack Weight	Pack Qty
10916	PROGRIP® 6" Painter's Taping Knife SS	Labeled	4	5
10918	PROGRIP® 8" Painter's Taping Knife SS	Labeled	4	5
10920	PROGRIP® 10" Painter's Taping Knife SS	Labeled	4	5
10922	PROGRIP® 12" Painter's Taping Knife SS	Labeled	4	5

STAINLESS STEEL TAPING KNIVES, PLASTIC HANDLE

Item #	Description	Type of Packaging	Pack Weight	Pack Qty
758	8" Taping Knife, Plastic Handle, Stainless Steel	Labeled	2	5
760	10" Taping Knife, Plastic Handle, Stainless Steel	Labeled	2	5
762	12" Taping Knife, Plastic Handle, Stainless Steel	Labeled	3	5



Items shaded in Blue denote Made in the USA

Mexican Heritage Taping Knives

These taping knives are made with pride to honor Mexican craftsmen. They are made to the same standards as our PROGRIP® taping knives.



PROGRIP® - BLUE STEEL TAPING KNIVES

Item #	Description	Type of Packaging	Pack Weight	Pack Qty
11541	PROGRIP® 8" Soft Grip Taping Knife, Blue Steel	Labeled	4	5
11542	PROGRIP® 10" Soft Grip Taping Knife, Blue Steel	Labeled	4	5
11543	PROGRIP® 12" Soft Grip Taping Knife, Blue Steel	Labeled	4	5

PROGRIP® -STAINLESS STEEL TAPING KNIVES

Item #	Description	Type of Packaging	Pack Weight	Pack Qty
11551	PROGRIP® 8" Soft Grip Taping Knife, Stainless Steel	Labeled	4	5
11552	PROGRIP® 10" Soft Grip Taping Knife, Stainless Steel	Labeled	4	5
11553	PROGRIP® 12" Soft Grip Taping Knife, Stainless Steel	Labeled	4	5

Painter's Series Taping Knives

Full-Tang, precision ground, mirror finish blade coated to prevent rust. Solvent resistant, durable plastic nylon handles. Carbon steel blades.



PAINTER'S SERIES—FLEX—CARBON STEEL

Item #	Description	Type of Packaging	Pack Weight	Pack Qty
11222	8" Flex Joint Knife, Hammer Cap™	Labeled	3	5
11223	10" Flex Joint Knife, Hammer Cap™	Labeled	3	5

Plastic Taping Knives

High-impact molded plastic are an excellent value.



PLASTIC TAPING KNIVES

Item #	Description	Type of Packaging	Pack Weight	Pack Qty
11080	8" Plastic Joint Knife	Labeled	2	20
11088	10" Plastic Joint Knife	Labeled	2	20
11361	2-Pack Joint Knife Set, 8" & 10"	Labeled	3	10

Items shaded in Blue denote Made in the USA



Sanders

Professional sanding heads, pads, and blocks are among the most forgiving in the industry. Thick, soft, and flexible pad, they help create the perfect joint or seam.

Hand Sanders

Hand sanders for finishing walls next to ceiling and corners. The sanding blocks are perfect for quick touch-ups or light duty projects around the house. Standard Acme Thread, 3/4"-5 x 1" on 3410497



HAND SANDERS

Item #	Description	Type of Packaging	Pack Weight	Pack Qty
229	Professional Hand Sander	Labeled	6	5
3410497	Lightweight Hand Sander, Plastic, Carded	Cut Carton	2.4	5
336	Rubber Sanding Block	Carded	3	5
34436	Sanding Block, carded	Cut Carton	3	10
11135	Drywall Sanding Sponge, bagged	Cut Carton	1	10

Sanding Blocks

Sanding blocks are perfect for quick touch-ups or light duty projects around the house.



HAND SANDERS

Item #	Description	Type of Packaging	Pack Weight	Pack Qty
34436	Sanding Block, carded	Cut Carton	3	10
336	Rubber Sanding Block	Carded	3	5

Pole Sanders & Wood Pole

Professional pole sanders with swivel head assures surface sanding contact without head tipping or rocking. All sanding heads accept standard die-cut sandpaper and 3/4" standard threaded extension poles. The wood pole of the #218 is made of Tauari. #10457 is a 5" wood extension pole with metal male threads. Fits standard 3/4" thread accessories. Standard Acme Thread, 3/4"-5 x 1"



POLE SANDERS

Item #	Description	Type of Packaging	Pack Weight	Pack Qty
256	Pole Sander Head, Female Threaded	Labeled	6	5
218	+Male Pole Sander with 48" Female Pole.	Labeled	3	1
3410496	Lightweight Pole Sander, Plastic, Head only, Female Threaded, Carded	Cut Carton	3.9	8

Saw

The ProCut® drywall saw has sawtooth grind, resulting in needle-sharp, long-lasting teeth. The 6-1/2" blade is extremely stiff with a chisel point. Ergonomic grip for comfort.



DRYWALL SAW

Item #	Description	Type of Packaging	Pack Weight	Pack Qty
625	ProCut® Drywall Saw 6 1/2" Blade	Carded	2	6



Bucket Scoop

BUCKET SCOOP

Item #	Description	Type of Packaging	Pack Weight	Pack Qty
11172	PROGRIP® Bucket Scoop	Labeled	1.65	5

Mud Pans

Mud pans for drywall compound are available in stainless steel, plastic and galvanized steel in 12" and 14" sizes. Mud pans #196 and #197 have heli-arc welded seams and are leakproof. The other metal mud pans listed are spot-welded construction. The Plastic Mud #221 pan features removable steel blades along each side for knife scraping and easy cleaning. The lightweight #10827 Grip & Go Plastic Mud Pan has a strap that makes it easier to grip, hold and maneuver on jobsite at all angles. The slots on the ends hold taping knives free from mud. Pan fits up to 10" knife.



MUD PANS

Item #	Description	Type of Packaging	Pack Weight	Pack Qty
196	14" Stainless Steel Heli-Arc Mud Pan	Labeled	15	10
206	12" Galvanized Mud Pan	Labeled	14	10
267	14" Galvanized Mud Pan	Labeled	16	10
207	12" Stainless Steel Mud Pan	Labeled	13	10
221	12" Plastic Mud Pan	Labeled	8	10
10827	10" Grip & Go™ Mud Pan	Cut Carton	7	6

Grip & Go™ Mud Pan US Patent Number **9,290,953 B2**

Perfect Pass™ Joint Knife

Revolutionary notched design makes filling drywall joints fast & easy. Tape drywall joints in 3 easy steps. Allows perfect amount of drywall compound every time. No sanding necessary. Fewer steps and less mess! The Perfect Pass™ Joint Knife has a full-tang, precision ground, and mirror finished 6" blade. Durable plastic handle with hammer cap™.



PERFECT PASS™ JOINT KNIFE

Item #	Description	Type of Packaging	Pack Weight	Pack Qty
10832	Perfect Pass™ Joint Knife, 6"	Carded	2	5
10846	Perfect Pass™ 10/Counter Display, #10832	Boxed	4	10

The Perfect Pass™ US Patent Number **7,647,668**.

No Pock!™

No Pock!™ is a drywall compound additive specifically formulated to reduce pock marks while increasing the workability of the compound by reducing friction.

No Pock!



NO POCK!™

Item #	Description	Type of Packaging	Pack Weight	Pack Qty
96	No Pock!™, 64 oz.	Bottle	21	2

Drywall Repair Patch

4" x 4" or 8" x 8" sizes. Self adhesive. Rustproof aluminum. Easy to install.



DRYWALL REPAIR PATCH

Item #	Description	Type of Packaging	Pack Weight	Pack Qty
11359	4"x4" Drywall Repair Patch	Envelope	1.1	12
11360	8"x8" Drywall Repair Patch	Envelope	2.5	10

Corner and Curved Trowels

#214 Stainless steel blade is corrosion-proof and long lasting. Adjustable trowel can handle a variety of wall-ceiling applications. Reversible handle on the adjustable trowel gives you two tip angles. Bull nose trowel # 148 is used to quick knock down mud on outside bull nose corners. 10947 & 10948 have stainless steel blades and soft grip handles.

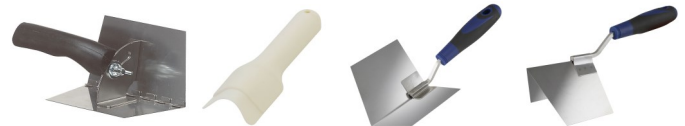

CORNER TROWELS

Item #	Description	Type of Packaging	Pack Weight	Pack Qty
214	Adjustable Inside Corner Trowel	Carded	3	4
148	Outside Bull Nose 3/4" Corner Trowel, Flex	Labeled	1	10
10947	+Inside Corner Trowel	Labeled	2	5
10948	+Outside Corner Trowel	Labeled	2	5

Rubber Float and Tile Grout Sponge

Floats are used for finishing or smoothing drywall compound, stucco, concrete or grout. Plastic handle, Aluminum back plate.

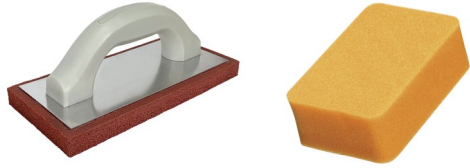

RUBBER FLOAT & SPONGE

Item #	Description	Type of Packaging	Pack Weight	Pack Qty
976	4" x 9" x 5/8" Rubber Masonry Float	Labeled	5	10
995	Tile & Grout Sponge	Bagged	2	24

Hawkbill Knife

Flooring knives for linoleum and vinyl flooring features hawkbill blades and turned hardwood handles. Both have high-carbon cutlery steel blades.



HAWKBILL KNIFE

Item #	Description	Type of Packaging	Pack Weight	Pack Qty
11277	Soft Grip SS Hawk Bill Linoleum Knife, with Cover	Carded	2.8	10

Adhesive Spreaders



ADHESIVE SPREADERS

Item #	Description	Type of Packaging	Pack Weight	Pack Qty
908	3" V-Notch Plastic Spreader, 3/16" Teeth	Labeled	2	20
909	3" Square-Notch Spreader, 1/16" Teeth	Labeled	2	20
10824	3" V-Notch Spreader, 2 pk	Labeled	2	5
11079	8" 1/8" Notched Plastic Adhesive Spreader	Labeled	2	20

Application Brush

Applicator brushes are used for applying masonry and stucco, adhesives and compounds. Plastic Bristle.



APPLICATOR BRUSH

Item #	Description	Type of Packaging	Pack Weight	Pack Qty
457	Texture-Masonry Brush	Labeled	4	10

Items shaded in Blue denote Made in the USA



Wallcovering Kit

A handy kit for light home decorating projects. This kit provides all the necessary tools for wallcovering that is not prepasted.



WALLCOVERING KIT

Item #	Description	Type of Packaging	Pack Weight	Pack Qty
581	Vinyl Wallcovering Set	Box	10	10

Brushes

Wallcovering brushes with the proper stiffness produces a professional appearance. The 495 is 10" long and made of polystyrene.



BRUSHES

Item #	Description	Type of Packaging	Pack Weight	Pack Qty
456	6" Pasting Brush	Labeled	3	10
495	2-Way Smoother, 3/4" Bristles (453)	Labeled	3	10

Seam Rollers

Double- or single-bracket construction, with plastic or wood rollers. Single-bracket roller works best in corners and along ceiling lines. Most feature contoured wooden handles.



SEAM ROLLERS

Item #	Description	Type of Packaging	Pack Weight	Pack Qty
422	1" Plastic Flat Seam Roller, Single Bracket	Labeled	2	10
416	1" Plastic Flat Seam Roller, Single Bracket	Labeled	1	10

Smoothers

Smoothers for virtually every need. They are made of plastic or foam and come in flexible or stiff for specific uses. #498 is made of polypropylene. #431 is made of polystyrene.



SMOOTHERS

Item #	Description	Type of Packaging	Pack Weight	Pack Qty
498	9" Plastic Smoother, Flexible	Labeled	4	20
431	Triple Edge Guide	Labeled	3	10

Accessory Tools

Specialized tools designed by wallcovering professionals to make projects go smoother, faster. They will help you save time and minimize problems.



WALLCOVERING ACCESSORIES

Item #	Description	Type of Packaging	Pack Weight	Pack Qty
428	12" Paint Guide	Labeled	3	10
433	23" Paint Guide & Wallcovering Tool	Labeled	6	10
250	Wallcovering Perforator, 19" Handle	Labeled	1	1
449	Wallcovering Sponge, 7 3/4" x 3 3/8" x 2 1/2"	Bagged	2	24

Items shaded in Blue denote Made in the USA



Bucket Tree Display

The bucket tree holds twelve clear buckets that contain a variety of key impulse items.



BUCKET TREE

Item #	Description	Pack Qty
10811	Warner Bucket Tree	
260	Wire Paint Can Opener, 100 Bulk	100
902	1-1/2" Flex Plastic Putty Knife	20
11500	Soft Grip Safety Scraper, with 5 Pack Tuck of Single Edge Blades	10
34114	Mini Glass Scraper/Blade Holder with 2 Blades, Carded	20
102	Bucket of Blades, 50 Tucks in a Bucket, .009"	50/Bucket
10798	8 Point 18MM Economy Snap-Off Blade Knife with 1 Blade, 25/Bucket	25/Bucket
10799	13 Point 9MM Economy Snap-Off Blade Knife with 1 Blade, 50/Bucket	50/Bucket
366	Top Trigger Utility Knife, with 3 Blades	10
360	Utility Blades, .025", Card of 5	10
10838	6" Long Nose Pliers	10
10839	6-in-1 Screwdriver	10
10840	16' Tape Measure	10
6164	Complete Spinner Tree w 12 Buckets	1
10887	Warner Header	1

Items shaded in Blue denote Made in the USA



Countertop Displays

Countertop displays boost selling impact and increase sales.



COUNTERTOP DISPLAYS

Item #	Description	Type of Packaging	Pack Weight	Pack Qty
90173	8-in-1 Painter's Tool	Labeled, 10/Counter Unit	4	10
90189	5-in-1 Painter's Tool, .080"	Labeled, 10/Counter Unit	3	10
90199	6-in-1 Painter's Tool	Labeled, 10/Counter Unit	4	10
10971	5-in-1 Painter's Tool, American Craftsman, RWB	Labeled, 10/Counter Unit	3	10
11102	8-in-1 Painter's Tool, Black Blade, RWB	Labeled, 10/Counter Unit	4	10
10830	7-in-1 Spray Wrench	Labeled, 10/Counter Unit	7	10
10495	15-in-1 Painter's Tool, 10/Counter Display	Labeled	5	10

COUNTERTOP DISPLAYS

Item #	Description	Type of Packaging	Pack Weight	Pack Qty
1039	Painter's 6-in-1 Scraper, 10/Counter Display, #379	Boxed	3	10
10846	Perfect Pass™ 10/Counter Display, #10832	Boxed	4	10
10847	Folding 12-in-1 Tool, 6/Counter Display, #10801	Clam in Ctr Disp	4	6
10848	6-in-1 Painter's Tool, 10/Counter Display, #10189	Boxed	4	10
11220	Painter's Series Pry Bar, 10/Counter Display, #11090	Boxed	4	10
11185	Folding & Locking Zinc Utility Knife, w/1 Blade, 10/Counter Disp	Card in Ctr Disp	5.5	10
11187	Folding & Locking Plastic Utility Knife, w/1 Blade, 10/Counter Disp	Card in Ctr Disp	5.8	10

Bucket Displays

Surveys show that almost 60% of store customers often buy items at the spur of the moment. Our bucket displays help attract and sell this bonus business.

BUCKET DISPLAYS

Item #	Description	Type of Packaging	Pack Weight	Pack Qty
101	Mini Glass Scraper/Blade Holder with 2 Blades, 25/Bucket	Bagged in Bkt	2	25
102	Bucket of Blades, 50 Tucks in a Bucket, .009"	Tucks in Bkt	5	50
261	Wire Paint Can Opener, 100/Bucket	Bucket	10	100
10798	8 Point 18MM Economy Snap-Off Blade Knife with 1 Blade, Uses #'s 120 & 10805	Bagged in Bkt	2	25
10799	13 Point 9MM Economy Snap-Off Blade Knife with 1 Blade, Uses #'s 116 & 10806	Bagged in Bkt	2	50
11093	3-in-1 Paint Can Clip, 16/CC	Cut Carton		16
11094	3-in-1 Paint Can Clip, 15/Bucket	Labeled in Bkt	2	15



101



102



261



11094

1092 PLASTIC SERIES DISPLAY

Item #	Description	Pack Qty
901	6" Flex Plastic Broad Knife	20
902	1-1/2" Flex Plastic Putty Knife	20
903	3" Flex Plastic Putty Knife	20
904	2" Flex Plastic Putty Knife	20
905	4" Flex Plastic Broad Knife	20
908	3" V-Notch Plastic Spreader	20
909	3" Square-Notch Plastic Spreader	20



This display comes with 16x5" header #103962 and wire rack w/ 10 hooks #103961

1081 DIY SERIES DISPLAY

Item #	Description	Pack Qty
180	1-1/4" Stiff Putty Knife	10
181	3" Stiff Scraper	10
182	1-1/4" Flex Putty Knife	10
183	3" Flex Putty Knife	10
184	4" Flex Broad Knife	10
186	6" Flex Broad Knife	10
185	5-in-1 Painter's Tool, Carbon Steel	10



This display comes with 16x5" header #103962 and wire rack w/ 10 hooks #103961

10337 PAINTER'S SERIES DISPLAY

Item #	Description	Pack Qty
504	3/4" Full Flex Putty Knife	5
10320	1-1/2" Flex Putty Knife	5
10327	1-1/2" Stiff Putty Knife	5
10322	3" Flex Putty Knife	5
10323	3" Stiff Scraper	5
10324	4" Flex Broad Knife, Hammer Cap™	5
10326	6" Flex Broad Knife, Hammer Cap™	5
10321	5-in-1 Painter's Tool	5
11090	Painter's Series Pry Bar, Hammer Cap™	5



This display comes with 16x5" header #103962 and wire rack w/ 10 hooks #103961

10858 ROSEWOOD SERIES DISPLAY

Item #	Description	Pack Qty
379	5-in-1 Painter's Tool, Carbon Steel Blade	5
609	1-1/2" Putty Knife, Stiff, Carbon Steel Blade	5
608	1-1/2" Putty Knife, Flex, Carbon Steel Blade	5
614	3" Putty Knife, Flex, Carbon Steel Blade	5
622	6" Broad Knife, Flex, Carbon Steel Blade	5
604	3/4" Putty Knife, Full Flex, Carbon Steel Blade	5
627	1-1/2" Putty Knife, Full Flex, Carbon Steel Blade	5
633	3" Putty Knife, Full Flex, Carbon Steel Blade	5
637	6" Broad Knife, Full Flex, Carbon Steel Blade	5

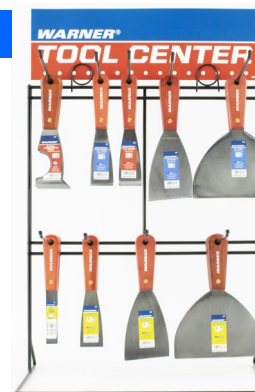

This display comes with 16x5" header #103404, 9 hooks #2859, and wire rack #101131.

11505 2' PUTTY KNIFE & SUNDRY ASSORTMENT

Item #	Description	Pack Qty
90101	PROGRIP® 1-1/4" Chisel Putty Knife	5
90115	PROGRIP® 3" Stiff Scraper, .060"	5
90108	PROGRIP® 1-1/2" Flex Putty Knife	5
90124	PROGRIP® 4" Flex Broad Knife, Hammer Cap™	5
90126	PROGRIP® 6" Flex Broad Knife, Hammer Cap™	5
90127	PROGRIP® 1-1/2" Full Flex Putty Knife	5
90189	PROGRIP® 5-IN-1 Painter's Tool	5
90173	PROGRIP® 8-IN-1 Painter's Tool, w/Hammer Cap	5
10321	Painter's Series 5-IN-1 Painter's Tool	5
10327	Painter's Series 1-1/2" Stiff Putty Knife	5
10320	Painter's Series 1-1/2" Flex Putty Knife	10
10324	Painter's Series 4" Flex Joint Knife	5
10326	Painter's Series 6" Flex Joint Knife	5
10801	The Painter's Blade® 12-in-1 Folding Knife	3
397	3" SS Bent Scraper w/Threaded Handle	6
11090	Painter's Series Pry Bar w/Hammer Cap™	10
34393	3" Plastic Refinishing Tool	15
34436	Sanding Block	10
34690	4" Big Blade Scraper, Steel Handle, 11-3/8" overall length	10
695	4" Big Blade Scraper Blades, Card of 5	10
10907	4" Glass and Tile Scraper, w/2 Blades	10
10485	Soft Grip Steel Wire Brush w/Scraper	6
11123	3-Pack SS Mini Brush Set	12
11160	2-IN-1 Painter's Brush	6
3410020	60MM (2-3/8") Carbide Scraper w/ Knob, Soft Grip Handle	5
814	60MM (2-3/8") Carbide Blade	10
411	Swivel Pot Hook	10
34114	Single Edge Scraper/Blade Holder, w/ 2 Blades	20
34129	10 Single Edge Razor Blades in Dispenser	10
11500	Glass Scraper w/ 5 Blades	10
10925	Warner 2' Header	1
2859	Hooks	30

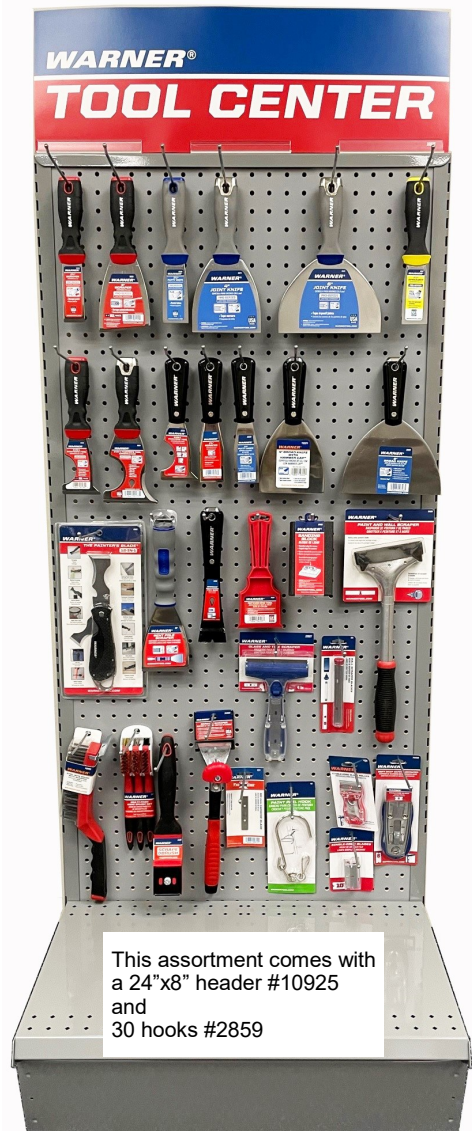

11025 WIRE BRUSH DISPLAY

Item #	Description	Pack Qty
10485	Soft Grip 12" Steel Wire Brush w/Scraper, 4x11	6
11160 (2)	2-IN-1 Painter's Brush	6
3410108	Soft Grip 3-in-1 Stripper Brush	10
10486	Soft Grip 10" Steel Shoe Handle Wire Brush, 4x16	6
3410493	Soft Grip Wide Stainless Stripper Brush, 5x11	12
3410491	Soft Grip Wide Nylon Stripper Brush, 5x11	12
3410487	Soft Grip Steel Scrub Brush w/ Scraper, 6x19, Threaded	8
11125	3-Pack SS Mini Wire Brush Set	12
11123	3-Pack MULTI Mini Wire Brush Set	12



This display comes with 16x5" header #103962 and wire rack w/ 10 hooks #103961

11011 PROGRIP® & SCRAPER ASSORTMENT A

This assortment comes with 12 hooks #2859

Item #	Description	Pack Qty
813	2" (50MM) Double Edge Carbide Replacement Blade, 1/Card	10
814	2-3/8" (60MM) Double Edge Carbide Replacement Blade, 1/Card	10
10018	2" (50MM) Carbide 100X® Soft Grip Scraper, w/Knob	5
10020	2-3/8" (60MM) Carbide 100X® Soft Grip Scraper, w/Knob	5
90108	PROGRIP® 1-1/2" Flex Putty Knife	5
90109	PROGRIP® 1-1/2" Stiff Putty Knife	5
90115	PROGRIP® 3" Stiff Scraper, .060"	5
90124	PROGRIP® 4" Flex Broad Knife, Hammer Cap™	5
90126	PROGRIP® 6" Flex Broad Knife, Hammer Cap™	5
90127	PROGRIP® 1-1/2" Full Flex Putty Knife	5
90133	PROGRIP® 3" Full Flex Putty Knife	5
90199	PROGRIP® 6-in-1 Hammer Cap™ .080"	10



11012 PUTTY KNIFE & SCRAPER ASSORTMENT B

This assortment comes with 27 hooks #2859

Item #	Description	Pack Qty
90189	PROGRIP® 5-in-1 Painter's Tool, .080"	10
90199	PROGRIP® 6-in-1 Hammer Cap™ .080"	10
90173	PROGRIP® 8-in-1 Hammer Cap™ .060"	10
90109	PROGRIP® 1-1/2" Stiff Putty Knife	5
90115	PROGRIP® 3" Stiff Scraper, .060"	5
90108	PROGRIP® 1-1/2" Flex Putty Knife	5
90124	PROGRIP® 4" Flex Broad Knife, Hammer Cap™	5
90126	PROGRIP® 6" Flex Broad Knife, Hammer Cap™	5
90127	PROGRIP® 1-1/2" Full Flex Putty Knife	5
90133	PROGRIP® 3" Full Flex Putty Knife	5
185	DIY Series 5-in-1 Painter's Tool, Carbon Steel	10
180	DIY Series 1-1/4" Stiff Putty Knife, Carbon Steel	10
183	DIY Series 3" Flex Putty Knife, Carbon Steel	10
184	DIY Series 4" Flex Broad Knife, Carbon Steel	10
186	DIY Series 6" Flex Broad Knife, Carbon Steel	10
10832	Perfect Pass™ 6" Joint Knife	5
10801	The Painter's Blade® 12-in-1 Folding Knife	3
10018	2" (50MM) Carbide 100X® Soft Grip Scraper, w/Knob	5
10020	2-3/8" (60MM) Carbide 100X® Soft Grip Scraper, w/Knob	5
813	2" (50MM) Double Edge Carbide Replacement Blade, 1/Card	10
814	2-3/8" (60MM) Double Edge Carbide Replacement Blade, 1/Card	10
709	2-1/2" PistolGrip™ Scraper w/Knob, 4-Edge	5
731	1-3/4" PistolGrip™ Scraper w/o Knob, 4-Edge	5
711	1-3/4" 4-Edge Blades, Card of 2	10
712	2-1/2" 4-Edge Blades, Card of 2	10
34690	4" Big Blade Scraper, Steel Handle, 11-3/8" overall length	10
695	4" Big Blade Scraper Blades, Card of 5	10



11013 PUTTY KNIFE & SCRAPER ASSORTMENT C

Item #	Description	Pack Qty
90189	PROGRIP® 5-in-1 Painter's Tool, .080"	10
90199	PROGRIP® 6-in-1 Hammer Cap™ .080"	10
90173	PROGRIP® 8-in-1 Hammer Cap™ .060"	10
90109	PROGRIP® 1-1/2" Stiff Putty Knife	5
90115	PROGRIP® 3" Stiff Scraper, .060"	5
90108	PROGRIP® 1-1/2" Flex Putty Knife	5
90124	PROGRIP® 4" Flex Broad Knife, Hammer Cap™	5
90126	PROGRIP® 6" Flex Broad Knife, Hammer Cap™	5
90127	PROGRIP® 1-1/2" Full Flex Putty Knife	5
90133	PROGRIP® 3" Full Flex Putty Knife	5
185	DIY Series 5-in-1 Painter's Tool, Carbon Steel	10
180	DIY Series 1-1/4" Stiff Putty Knife, Carbon Steel	10
183	DIY Series 3" Flex Putty Knife, Carbon Steel	10
184	DIY Series 4" Flex Broad Knife, Carbon Steel	10
186	DIY Series 6" Flex Broad Knife, Carbon Steel	10
10832	Perfect Pass™ 6" Joint Knife	5
10801	The Painter's Blade® 12-in-1 Folding Knife	3
10018	2" (50MM) Carbide 100X® Soft Grip Scraper, w/Knob	5
10020	2-3/8" (60MM) Carbide 100X® Soft Grip Scraper, w/Knob	5
813	2" (50MM) Double Edge Carbide Replacement Blade, 1/Card	10
814	2-3/8" (60MM) Double Edge Carbide Replacement Blade, 1/Card	10
709	2-1/2" PistolGrip™ Scraper w/Knob, 4-Edge	5
731	1-3/4" PistolGrip™ Scraper w/o Knob, 4-Edge	5
711	1-3/4" 4-Edge Blades, Card of 2	10
712	2-1/2" 4-Edge Blades, Card of 2	10
34690	4" Big Blade Scraper, Steel Handle, 11-3/8" overall length	10
695	4" Big Blade Scraper Blades, Card of 5	10
752	12" Blue Steel Taping Knife, Plastic Handle	5
750	10" Blue Steel Taping Knife, Plastic Handle	5
748	8" Blue Steel Taping Knife, Plastic Handle	5

This assortment comes with 30 hooks #2859



Power Tower™ Series—The Brightest, Most Powerful Bull Dogs!



BD 1000MH

P11000W 1000W Single Metal Halide Portable Light Cart

- 1000W weatherproof fixture
- Mast extends from 7', 10', 12.5'
- 8 ft. 14/3 AWG SJTOW
- 5 year limited warranty

Lumen Output: 110,000
Power: 120V-60Hz
Amps: 9.2
Shipping Wt: 165 lbs
UPC: 7-24281-01016-8



BD 2000MH

P12000W 2000W Dual Metal Halide Portable Light Cart

- Dual 1000W weatherproof fixtures
- 30 Amp 125V Locking Plug L5-30
- Mast extends from 7', 10', 12.5'
- 8 ft. 12/3 AWG SJTOW
- 5 year limited warranty

Lumen Output: 220,000
Power: 120V-60Hz
Amps: 18.4
Shipping Wt: 200 lbs
UPC: 7-24281-01017-5



BDW 1000MH

P14000W 1000W Single Metal Halide Portable Light Cart with Winch

- 1000W weatherproof fixture
- Mast extends from 7' to 12.5'
- 8 ft. 14/3 AWG SJTOW
- 5 year limited warranty

Lumen Output: 110,000
Power: 120V-60Hz
Amps: 9.2
Shipping Wt: 165 lbs
UPC: 7-24281-14000-1



BDW 2000MH

P16000W 2000W Dual Metal Halide Portable Light Cart with Winch

- Dual 1000W weatherproof fixtures
- 30 Amp 125V Locking Plug L5-30
- Mast extends from 7' to 12.5'
- 8 ft. 12/3 AWG SJTOW
- 5 year limited warranty

Lumen Output: 220,000
Power: 120V-60Hz
Amps: 18.4
Shipping Wt: 200 lbs
UPC: 7-24281-16000-9



DUAL POWER OPTIONS:

- 1,000 Watt models plug into any 15 Amp, 120 Volt power source
- 2,000 Watt models require a 30 Amp, 120 Volt power source
- 2,000 Watt models have a 30 Amp 125 Volt Locking Plug L5-30



Shown in Transport Mode.

Compact Enough to go
Anywhere!

Only 30" High!

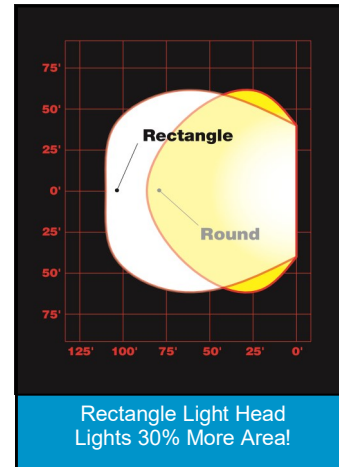

ALSO SEE OUR 45,000 LUMEN 300W LED PORTABLE LIGHT CART, PAGE 2

5-year Limited Warranty
See www.bulldogpower.com or
call 800-444-0606 for details

Orders & Information
Phone: 800-444-0606
Fax: 877-927-6370
customerservice@warnertool.com

Read and follow any
safety related information
in or on the product and
packaging.

Power Towers™
Turn Night Into Day!

Complies with ANSI Standards
incorporated by OSHA regulations.

Metal Halide Bulb—Built Bull Dog Tuff



MH 1000WB

P100817

1000W Metal Halide Bulb for the Rectangle P11000W, P12000W, P14000W, & P16000W. BT37, 1000W, Metal Halide, Mogul Screw (E39), Operating Position: U (universal burning position), Fixture Type: Enclosed, ANSI No. M47, Lumens: 110,000, CRI: 65.

Shipping Wt: 3 lbs
UPC: 7-24281-10817-9

Contact Bull Dog—Warner
Customer Service for
Metal Halide Light Tower parts
at 800-444-0606 or
customerservice@warnertool.com

Halogen Bulbs—Built Bull Dog Tuff



3-PACK

P10174
+3-Pack 500W Quartz Halogen Bulbs, Clam Shell

T3, 500W, 120V, Quartz Halogen, 4-11/16" length, 3/8" dia., 2000 hours.

Lumens: 10,000
Watts: 500
Shpng Wt: 2 lbs
UPC: 7-24281-10174-3

Complies with ANSI Standards incorporated by OSHA regulations.

Read and follow any safety related information in or on the product and packaging.

Orders & Information
Phone: 800-444-0606
Fax: 877-927-6370
customerservice@warnertool.com

LED Series—Towers

52,500 Lumen 300W LED Light Cart

P11300
52,500 Lumen 300W LED Portable Light Cart

- Three powerful LED light banks project the light over 175' and create more usable light than 1000W metal halide bulb and consume 70% less energy
- The P11300 is safer more energy efficient lighting solution for large areas
- The P11300 provides instant start-up full power lighting even in extreme cold temps
- Super bright LED provides 52,500 Lumens
- Improved safety with tip over switch, automatic shut off
- No Light bulb to break or replace. COB technology
- Lights up to 30,000 sq. ft.
- Mast extends, from 6.5' to 9' overall height
- Weatherproof on/off switch
- Can be used with most small portable generators
- Portable, quickly packs for easy transport
- Light Output: Lights up to 30,000 sq. ft.
- 1 year limited warranty



52,500
LUMEN

**Weatherproof!
Instant-ON
Tip Over Switch!**

Lumens: 52,500
Watts: 300, Amps: 2.5
Power: 120V-60Hz
IP Rating: IP64 Suitable for outdoor-wet locations
Cord: 5' 16/3 AWG SJTOW with standard plug
Color Temp: 4000-5000K
Shpng Wt: 124 lbs
UPC: 7-24281-11300-5



105,000 Lumen 600W LED Light Cart

P11600
105,000 Lumen 600W LED Portable Light Cart

- Six powerful LED light banks create more usable light than 1000W metal halide bulb and consume 70% less energy
- The P11600 is safer more energy efficient lighting solution for large areas
- The P11600 provides instant start-up full power lighting even in extreme cold temps
- Super bright LED provides 105,000 Lumens
- Improved safety with tip over switch, automatic shut off
- No Light bulb to break or replace. COB technology
- Lights up to 60,000 sq. ft.
- Mast extends, from 6.5' to 9' overall height
- Weatherproof on/off switch
- Can be used with most small portable generators
- Portable, quickly packs for easy transport
- Light Output: Lights up to 105,000 sq. ft.
- 1 year limited warranty

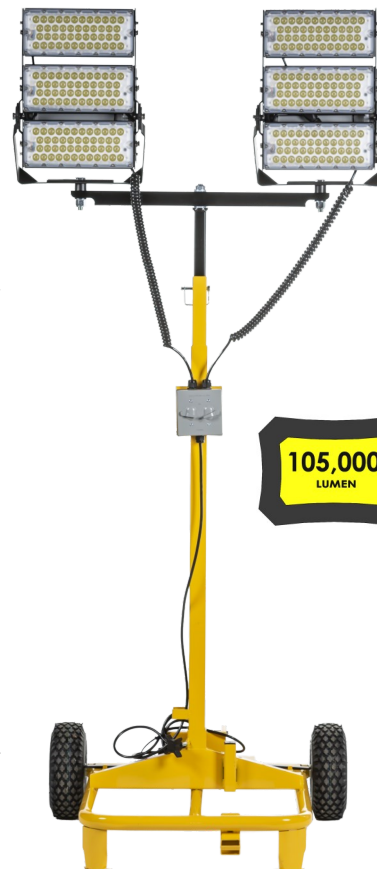

105,000
LUMEN

Lumens: 105,000
Watts: 600, Amps: 5
Power: 120V-60Hz
IP Rating: IP64 Suitable for outdoor-wet locations
Cord: 5' 16/3 AWG SJTOW with standard plug
Color Temp: 4000-5000K
Shpng Wt: 145 lbs
UPC: 7-24281-11600-6



**Shown in transport mode.
Only 35" tall!
Portable, quickly packs
for easy transport.**



Complies with ANSI Standards incorporated by OSHA regulations.

Read and follow any safety related information in or on the product and packaging.

1-year Limited Warranty
See www.bulldogpower.com or call 800-444-0606 for details

360° LED Power Tower™ Double Head

P11310
36,000 Lumen 300W LED Portable Light Cart

- Lights up to 17,500 sq. ft
- 150 ft. diameter light projection
- 2 360° area light fixtures
- Two super bright LED provides 36,000 Lumens
- Two each 150W weatherproof 360° fixtures
- Mast height settings of 7', 10' & 12.5'.
- Can be used with most small portable generators
- Portable, quickly packs for easy transport
- 1 year limited warranty

Lumens: 36,000
Watts: 300, Amps: 2.5
Power: 120V-60Hz
IP Rating: IP63 Suitable for damp locations
Cord: 5' 18/3 AWG SJTOW with std plug
Color Temp: 4000-5000K
Shpng Wt: 124 lbs
UPC: 7-24281-11310-4



Shown in transport mode.
Only 35" tall!
Portable, quickly packs
for easy transport.

Complies with ANSI Standards
incorporated by OSHA regulations.

Read and follow any
safety related information
in or on the product and
packaging.

30,000 Lumen 256W LED Light Cart

P30000
30,000 Lumen LED Portable Light Cart

- Lights up to 26,250 sq. ft
- 150 ft. diameter light projection
- 2 Heads can be turned 360 degrees for versatile light spread
- Two powerful SMD LED provides 30,000 Lumens
- Two each 15,000 Lumen weatherproof 360° fixtures with on/off switches
- Mast height settings of 7', 10' & 12.5'.
- Can be used with most small portable generators
- Portable, quickly packs for easy transport
- 1 year limited warranty

Lumens: 30,000/15,000
Watts: 256, Amps: 2.5
Power: 120V-60Hz
IP Rating: IP44 Suitable for outdoor-wet locations
Cord: 5' 18/3 AWG SJTOW with standard plug
Color Temp: 4000-5000K
Shpng Wt: 124 lbs
UPC: 7-24281-30000-9



1-year Limited Warranty
See www.bulldogpower.com or call 800-444-0606 for details

LED Series—Rechargeable

1000 Lumen Rechargeable LED

10998U +1000/500 Lumen Rechargeable LED Worklight



Tri-Pod
Stand
NOT
included



Super bright LED provides 850 Lumens.
Cool touch SMD LED technology.
High and Low brightness settings, and Strobe.
Rechargeable lithium ion battery.
180° rotating stand.
Includes USB charging cable.
Weatherproof on/off switch. Quick release connection.
Will work with #11067.
1 year limited warranty.

Lumens: 1000 High/500 Low
Watts: 10
Power: Rechargeable Lithium-ion Battery
Charging Time: 5 hours
Working Time: 3 Hours High/5 Hours Low
IP Rating: IP44 Suitable for wet locations
Cord: USB charging cord included
Color Temp: 4000K
Shpng Wt: 1.5 lbs
UPC: 0-48661-10998-4

Tripod Stand

11067 3'-5' Tripod Floor Stand

Quick Release Connection
Stand fits Warner worklights #'s
**11255, 11282, 11378, 11379,
11388, 10998U, 11441 & 11443**
1 year limited warranty
Shpng Wt: 6 lbs
UPC: 0-48661-11067-6



**Unique interchangeable
system allows 11255, 11378,
11379, 11388, 10998U,
11441 & 11443
to fit & lock into
11067 tri-pod stand**

Complies with ANSI Standards
incorporated by OSHA regulations.

Read and follow any
safety related information
in or on the product and
packaging.

See www.bulldogpower.com or call 800-444-0606 for details

42

1-year Limited Warranty
Orders & Information
Phone: 800-444-0606
Fax: 877-927-6370
customerservice@warnertool.com

LED Series—AC Corded

4000 Lumen LED

11378 4500 Lumen LED Portable Worklight

High brightness and high efficiency SMD LED. Cool touch SMD LED technology. Durable die-cast aluminum housing is mounted on a metal H-Frame base with non-skid feet. Weatherproof on/off switch. Quick release connection. Will work with #11067. #11067 not included. 1 year limited warranty.



Lumens: 4500
Watts: 32
Light Beam Distance: 288 Ft./88M
Power: 110V AC
Amps: .29
IP Rating: IPX4 Suitable for wet locations
Cord: 6 ft. 18/3 AWG SJTW
Color Temp: 4000-5000K
Shpng Wt: 3lbs
UPC: 0-48661-11378-3



Tri-Pod
Stand
NOT
included

7000 Lumen LED

11379 7000 Lumen LED Portable Worklight

High brightness and high efficiency SMD LED. Cool touch SMD LED technology. Durable die-cast aluminum housing is mounted on a metal H-Frame base with non-skid feet. Weatherproof on/off switch. Quick release connection. Will work with #11067. #11067 not included. 1 year limited warranty.



Lumens: 7000
Watts: 72
Light Beam Distance: 321 Ft./98m
Power: 110V AC
Amps: .65
IP Rating: IPX4 Suitable for wet locations
Cord: 6 ft. 18/3 AWG SJTW
Color Temp: 4000-5000K
Shpng Wt: 4 lbs
UPC: 0-48661-11379-0



Tri-Pod
Stand
NOT
included

2000 Lumen LED

11443 2000 Lumen LED Worklight

Super bright LED provides 2000 Lumens. Cool touch SMD LED technology. Continuous Light—No Switch. Durable die-cast aluminum housing is mounted on a metal H-Frame base. Quick release connection. Will work with #11067. 1 year limited warranty.



Tri-Pod
Stand
NOT
included

Lumens: 2000
Watts: 20
Light Beam Distance: 177 Ft./154M
Power: 110V AC
Amps: .18
IP Rating: IP44 Suitable for wet locations
Cord: 5 ft. 18/3 AWG SJTW
Color Temp: 4000-5000K
Shpng Wt: 3 lbs
UPC: 0-48661-11443-8



8000 Lumen LED

11388 9000 Lumen LED Portable 2-Fixture Worklight

Can be used as a floor light or on the tripod. Portable light stand folds for storage or transport. Light heads rotate upwards, and left & right. Powerful LED for large worksites. Dual weatherproof on/off switches. Quick release connection. Will work with #11067. #11067 not included. 1 year limited warranty.



Lumens: 9000
Watts: 64
Light Beam Distance:
Power: 110V AC
Amps: .58
IP Rating: IPX4 Suitable for wet locations
Cord: 6 ft. 10/3 AWG SJTW
Color Temp: 4000-5000K
Shpng Wt: 7 lbs
UPC: 0-48661-11388-2



Complies with ANSI Standards incorporated by OSHA regulations.

Read and follow any safety related information in or on the product and packaging.

1-year Limited Warranty
See www.bulldogpower.com or call 800-444-0606 for details

Orders & Information
Phone: 800-444-0606
Fax: 877-927-6370
customerservice@warnertool.com

LED Series—Battery & Rechargeable

220 Lumen Pocket LED Worklight

11179 +220 Lumen 3W Pocket LED Worklight, 12/Counter Display

High brightness and high efficiency COB LED. Use hand free with the 180° swivel rotating magnetic clip or the powerful magnetic base. Top button on/off switch. Tough/Durable aluminum body. 6.5" overall length. Uses 3 AAA batteries included. 1 year limited warranty.

Lumens: 220
Watts: 3
Power: 3 AAA Batteries
IP Rating: IP44 Suitable for wet locations
Cord: No Cord
Color Temp: 4000-5000K
Shpng Wt: 3 lbs
UPC: 0-48661-11179-6



220 Lumen 4-in-1 LED Worklight

11177 +220 Lumen 3W 4-in-1 LED Worklight, 6/Counter Display

High brightness and high efficiency COB LED. High and low brightness settings. Multi-directional rotating/swiveling hands free 4-in-1 worklight. 360° swivel hook. Directional flashlight on top. Powerful magnet on the base. ABS rubberized body. Uses 3 AA batteries included. 1 year limited warranty.

Lumens: 220 High/60 Low
Watts: 3
Power: 3 AA Batteries
IP Rating: IP44 Suitable for wet locations
Cord: No Cord
Color Temp: 4000-5000K
Shpng Wt: 4 lbs
UPC: 0-48661-11177-2



Complies with ANSI Standards incorporated by OSHA regulations.

Read and follow any safety related information in or on the product and packaging.

See www.bulldogpower.com or call 800-444-0606 for details

1-year Limited Warranty

Orders & Information

Phone: 800-444-0606

Fax: 877-927-6370

customerservice@warnertool.com

LED Series—Headlamps—Battery & Rechargeable

370 Lumen Wide Beam LED Headlamp

11267

370 Lumen Wide Beam LED Headlamp, w/Spotlight, 10/Counter Display

Wide angle COB LED beam for maximum light. Spotlight XPE LED. Sensor switch. 3 Settings – High, Low, Safety Strobe. 1" Adjustable elastic band. Weatherproof on/off switch. Charging cord included. 1 year limited warranty.

Lumens: 370
Watts: 3
Light Beam Distance: 33 Ft./10M—108 Wide Beam
Power: Rechargeable Lithium-ion Battery
Charging Time: 3.5 Hours
Working Time: 6.5 Hours High/3.5 Hours Low
IP Rating: IPX4 Suitable for wet locations
Cords: Charging Cord Included
Color Temp: 4000-5000K
Shpng Wt: 2 lbs
UPC: 0-48661-11267-0



160/70 Lumen LED Headlamp

+11265

160/70 Lumen 3W LED Headlamp, 8/Counter Display



3 Settings: high, low and safety strobe. Tilting head to focus light. Double elastic strap for maximum comfort. 3 AAA batteries included. Weatherproof on/off switch. 1 year limited warranty.

Lumens: 160 High/70 Low
Watts: 3
Light Beam Distance: 50 Ft./15M Wide Beam; 130 Ft./40M Focused Beam
Power: 3 AAA Batteries included
Charging Time: NA
Working Time: Up to 7/9 hours
IP Rating: IPX2 Suitable for wet locations
Cords: NA
Color Temp: 4000-5000K
Shpng Wt: 2 lbs
UPC: 0-48661-11265-6



200 Lumen Clip-On LED Headlamp

+11266

200 Lumen 3W Clip-On LED Headlamp, 12/Counter Display



Lightweight headlamp attaches securely to brim. Focus light without interfering with your vision. Quickly clips on brim of hat. Wide angle beam. 3 AAA batteries included. Weatherproof on/off switch. 1 year limited warranty.

Lumens: 200
Watts: 3
Light Beam Distance: 60 Ft./18M
Power: 3 AAA Batteries included
Charging Time: NA
Working Time: Up to 5 hours
IP Rating: IPX2 Suitable for wet locations
Cords: NA
Shpng Wt: 2 lbs
UPC: 0-48661-11266-3



High Power LED Headlamp

11373

300/90 Lumen LED Headlamp

3 Settings: high, low and safety strobe. Tilting head to focus light. Double elastic strap for maximum comfort. 3 AAA batteries included. Weatherproof on/off switch. 1 year limited warranty.

Lumens: 300 High/90 Low
Watts: 5
Light Beam Distance: 134 Ft./41M
Power: 3 AAA Batteries included
Charging Time: NA
Working Time: Up to 7 hours
IP Rating: IPX2 Suitable for wet locations
Cords: NA
Color Temp: 4000-5000K
Shpng Wt: 2 lbs
UPC: 0-48661-11265-6



Complies with ANSI Standards incorporated by OSHA regulations.

Read and follow any safety related information in or on the product and packaging.

See www.bulldogpower.com or call 800-444-0606 for details

1-year Limited Warranty

Orders & Information

Phone: 800-444-0606

Fax: 877-927-6370

customerservice@warnertool.com

Item #	Description	Page #	Item #	Description	Page #	Item #	Description	Page #
96	64 oz. No Pock!™ 4-Pack	29	495	2-Way Smoother	30	820	Blade Sharpening File	13
101	Mini Glass Scraper/Razor Blade Holder in Bucket	16, 33	498	9" Plastic Smoother	31	828	22 MM (7/8") Carbide 100X® Triangle Blade	12
102	Bucket of Blades, 50 Tucks in a Bucket	16, 33	502	1-1/4" Bent Putty Knife, Stainless Steel	11	901	6" Flex Plastic Joint Knife	10
109	100 Bulk Razor Blades	16	503	3/4" Stiff Putty Knife, Chisel Edge	11	902	1-1/2" Flex Plastic Putty Knife	10
102395	Mini Glass Scraper/Razor Blade Holder Bagged	16	504	3/4" Full Flex Putty Knife	11	903	3" Flex Plastic Putty Knife	10
116	13 Point 9MM Snap-Off Blades	17	543	+5 Gallon Plastic Bucket	21	904	2" Flex Plastic Putty Knife	10
117	13 Point 9MM Ergo Snap-Off Blade Knife	17	556	Plastic Pail Opener	20	905	4" Flex Plastic Joint Knife	10
119	8 Point 18MM Ergo Snap-Off Blade Knife	17	566	Safety 1st™ Self-Retracting Utility Knife	17	908	3" V-Notch Plastic Spreader	10,30
120	8 Point 18MM Snap-Off Blades	17	572	Mini Brush Set	22	909	3" Square-Notch Plastic Spreader	10,30
138	Glass Cutter	19	581	Vinyl Wallcovering Set	31	976	4" x 9" x 5/8" Rubber Float	30
142	Glazier Push Points, Size #7, Carded, approx. 50	19	591	5" HD Floor Scraper, 47-1/4" Steel Handle	15	995	Tile and GROUT Sponge	31
144	Aluminum Lid Cutter/Opener/Closer	20	595	5" Scraper Blades, 5/Card	15	1039	Painter's 6-in-1 Countertop Display	34
148	3/4" Outside Bull Nose Corner Trowel	29	599	5" Scraper Blades, 50/Bulk	15	1081	180 Line Tool Display	34
180	1-1/4" Stiff Putty Knife, Carbon Steel	10	601	1-1/4" Chisel Putty Knife, Rosewood Handle	8	1092	900 Line Display	33
181	3" Stiff Scraper, Carbon Steel	10	604	3/4" Full Flex Putty Knife, Rosewood Handle	8	5791	Clear Bucket for Bucket Tree	32
182	1-1/4" Stiff Putty Knife, Carbon Steel	10	606	1-1/4" Flex Putty Knife, Rosewood Handle	8	6473	Spring Kit for # 10770 & 10771	23
183	3" Flex Putty Knife, Carbon Steel	10	608	1-1/2" Flex Putty Knife, Rosewood Handle	8	6476	Wing Bolt Kit for # 10770 & 10771	23
184	4" Flex Joint Knife, Carbon Steel	10	609	1-1/2" Stiff Putty Knife, Rosewood Handle	8	7090	Nylon Bushing Kit for # 10770 & 10771	23
185	5-in-1 Painter's Tool, Carbon Steel	10	610	2" Flex Putty Knife, Rosewood Handle	8	8150	3-Pack Plastic Putty Knives	10
186	6" Flex Joint Knife, Carbon Steel	10	614	3" Flex Putty Knife, Rosewood Handle	8	10000	Paint Can Opener, 2/card	20
196	14" Stainless Steel Heli-Arc Mud Pan	29	615	3" Stiff Scraper, Rosewood Handle	8	10011	1-5 Gallon Paint/Epoxy Mixer, 18-3/4" Long Shaft, 3/8" Drill	20
206	12" Galvanized Mud Pan	29	618	4" Flex Joint Knife, Rosewood Handle	8	10016	22 MM (7/8") Triangle Carbide 100X® Soft Grip Scraper	12
207	12" Stainless Steel Mud Pan	29	620	+5" Flex Joint Knife, Rosewood Handle	8	10018	50MM(2") Carbide 100X® Soft Grip Scraper w/ Knob	12
214	Adjustable Inside Corner Trowel	29	621	1-1/4" Full Flex Putty Knife, Rosewood Handle	8	10020	60MM(2-3/8") Carbide 100X® Soft Grip Scraper w/ Knob	12
218	+Pole Sander & Pole	28	622	6" Flex Joint Knife, Rosewood Handle	8	10024	2-Pack Brass Mini Brush	22
221	12" Plastic Mud Pan	29	625	ProCut® Drywall Saw	28	10031	Super Soft Knee Pads	19
229	Pro HD Hand Sander	28	627	1-1/2" Full Flex Putty Knife, Rosewood Handle	8	10050	36" Alum Spray Shield, Adj. Swivel Head, 18" Wood Hdl	19
250	Wallcovering Perforator	31	628	2" Full Flex Putty Knife, Rosewood Handle	8	10053	36" Bent Alum Spray Shield, 18" Plastic Hdl	19
256	Pole Sander Head	28	633	3" Full Flex Putty Knife, Rosewood Handle	8	10056	5 Quart Measuring Container	21
260	Wire Paint Can Opener, 100 Bulk, Box	20	635	4" Full Flex Joint Knife, Rosewood Handle	8	10059	5 Quart Container Lid	21
261	Wire Paint Can Opener, 100/Bucket	20, 33	636	5" Full Flex Joint Knife, Rosewood Handle	8	10090	Leg with Rubber Pad Attached for #10329	25
262	Steel Extension Pole 4' - 6.5'	18	637	6" Full Flex Joint Knife, Rosewood Handle	8	10100	Utility Scraper w/ 3 Blades	14
267	14" Galvanized Mud Pan	29	657	6" SS Easy Reach™ Bent Scraper, Thd Handle	14	10121	5 Gallon Paint Mixer, 15-3/4" Long Shaft, 3/8" Drill, 6/CC	20
269	Brush Comb & Roller Cleaner	21	691	4" Wall Scraper, 5" Handle	15	10125	48" Aluminum Spray Shield, 18" Plastic Hdl	19
279	Brush and Roller Cleaner	21	693	4" Floor Scraper, 48" Handle	15	10127	Rubber Foot Pad for #10329	25
305	24" Plastic Spray Shield, 18" Plastic Handle	19	695	4" Wall Scraper Blades, 5/Card	15	10144	4" Mexican Heritage Flex Joint Knife	7
308	36" Plastic Spray Shield, 12" Plastic Handle	19	698	4" Wall Scraper Blade Disp, 10 cds of 10 blds	15	10145	5" Mexican Heritage Flex Joint Knife	7
336	Rubber Sanding Block	28	699	4" Wall Scraper Blades, 100/Bulk	15	10146	6" Mexican Heritage Flex Joint Knife	7
340	1 Gallon Paint Mixer, 22-3/4" long shaft, 1/2" drill	20	708	1-3/4" PistolGrip™ Scraper w/ Knob, 4-Edge	13	10160	Rplcmnt Ext Leg Braces/Step for #10040, 2 ea	25
341	5 Gallon Paint Mixer, 2-3/8" Spiral, 15-3/4" long shaft, 3/8" drill	20	709	2-1/2" PistolGrip™ Scraper w/ Knob, 4-Edge	13	10179	31" Cardboard for Spray Shield	19
343	Drywall Compound Mixer	20	711	1-3/4" 4-Edge Blades, 2/Card	13	10187	Plastic Spray Shield Holder	19
356	Safety 1st™ Utility Scraper	16	712	2-1/2" 4-Edge Blades, 2/Card	13	10189	Mexican Heritage 6-in-1	7
360	Utility Blades	16	731	1-3/4" PistolGrip™ Scraper w/o Knob, 4-Edge	13	10225	EZ-Stride® Step-Up Bench 24"	24
366	Top Trigger Utility Knife	17	741	2-1/2" Scraper, 2-Edge	13	10227	EZ-Stride® Step-Up Bench 35"	24
379	5-in-1 Painter's Tool, Rosewood Handle	8	742	1" Scraper, 2-Edge	13	10232	Side Pole Kit 24" for #10771	23
380	Roller-Brush Cleaner	21	746	6" Drywall Blue Steel Taping Knife	26	10233	Side Pole Kit 18" for #10770	23
387	Bent Burn-Off Scraper, Long Handle	14	748	8" Drywall Blue Steel Taping Knife	26	10238	Leg Support Cuff Kit for #10770 & 10771	23
393	3" Plastic Refinishing Tool	14	750	10" Drywall Blue Steel Taping Knife	26	10239	Upper Side Pole Clamping Kit for #10770 & 10771	23
395	Double Ended Window Tool	19	752	12" Drywall Blue Steel Taping Knife	26	10263	Brush Extension	19
397	3" SS Easy Reach™ Bent Scraper, Thd Handle	14	758	8" Drywall Stainless Steel Taping Knife	26	10296	Foot Pad Kit for EZ-Stride® Step-Up Benches	24
398	3" SS Easy Reach™ Scraper, Thd Handle	14	760	10" Drywall Stainless Steel Taping Knife	26	10297	24" & 29" Spreader Bar Kit for #10225 & 10226	24
411	Swivel Pot Hook	19	762	12" Drywall Stainless Steel Taping Knife	26	10298	35" & 46" Spreader Bar Kit for #10227 & 10228	24
412	Handy Pot Hooks, 2/card	19	790	4" Strip 'N' Clean™ Scraper, 12" Handle	15	10309	15-in-1 Painters Tool	9
416	1" Plastic Flat Seam Roller	31	791	4" Strip 'N' Clean™ Scraper, 18" Handle	15	10314	Hinge Kit for EZ-Stride® Step-Up Benches	24
419	36" Aluminum Spray Shield, 18" Plastic Hdl	19	792	4" Strip 'N' Clean™ Scraper, 43.5" Handle	15	10320	1-1/2" Flex Putty Knife, Carbon Steel	11
422	1" Plastic Flat Seam Roller, SB	31	793	4" Strip 'N' Clean™ Blade, 1/Card	15	10321	5-in-1 Painter's Tool, Carbon Steel, 1.2mm=.047"	11
428	12" Paint Guide	20, 31	794	6" Strip 'N' Clean™ Blade, 1/Card	15	10322	3" Flex Putty Knife, Carbon Steel	11
431	Triple Edge Guide	20, 31	BD10360	Bull Dog™ 6" HD Floor Scraper, 49" Hdl	15	10323	3" Stiff Scraper, Carbon Steel	11
432	15" Paint Guide	20	803	50 MM (2") Carbide 100X® Scraper w/o Knob	12	10324	4" Joint Knife w/ Hammer Cap™, Carbon Steel	11
433	23" Pt Guide & Wallcovering Tool	20, 31	804	50 MM (2") Carbide 100X® Scraper w/ Knob	12	10326	6" Joint Knife w/ Hammer Cap™, Carbon Steel	11
434	10" Paint Guide	20	807	60 MM (2-3/8") Carbide 100X® Scraper w/ Knob	12	10327	1-1/2" Stiff Putty Knife, Carbon Steel	11
447	1 Gallon 2" Plastic Paint Mixer	20	808	22 MM (7/8") Carbide 100X® Scraper w/o Knob	12	10328	1-1/4" Stiff Chisel Edge Putty Knife, Carbon Steel	11
449	Wallcovering Sponge	31	810	1" 2-Edge Blades	13	10329	EZ-Stride® Drywall Bench	25
456	6" Pasting Brush	31	811	1-3/4" 2-Edge Blades	13	10330	1 Gallon Plastic Paint Mixer	20
457	Texture-Masonry Brush	30	812	2-1/2" 2-Edge Blades	13	10331C	5 Gallon Plastic Paint Mixer	20
			813	50 MM (2") Double Edge Carbide Blade	12	10337	Painter's Series Display	11,34
			814	60 MM (2-3/8") Double Edge Carbide Blade	12			
			816	60MM (2-3/8") Double Edge Carbide Blades,10/PK	12			
			819	50 MM (2") Double Edge Carbide Blades, 10/PK	12			

Items shaded in Blue denote Made in the USA



Item #	Description	Page #	Item #	Description	Page #	Item #	Description	Page #
10345	Replacement Step for #10329	25	10871	PROGRIP® 8" Blue Steel Soft Grip Taping Knife	26	11462	Wood Handle 10" Wire Brush w/Scraper, 4x11 row	22
10350	Painter's Pry Bar	20	10872	PROGRIP® 10" Blue Steel Soft Grip Taping Knife	26	11463	Wood Handle 10" Wire Brush w/ Scraper, 4x16 row	22
10351	+Painter's Knife	5	10873	PROGRIP® 12" Blue Steel Soft Grip Taping Knife	26	11464	Wood Scrub Brush, Threaded, 6x19 row	22
10389	+HD Caulk Remover	11	10879	PROGRIP® 14" Blue Steel Soft Grip Taping Knife	26	11469	Wood Handle 10" S.S. Wire Brush, 4x16 row	22
10419	10" HD Floor Scraper, 49" Handle	15	10907	4" Glass & Tile Scraper, w/2 Blades	16	11471	Wood Handle 13" S.S. Wire Brush, 3x19 row	22
10423	10" HD Blade for #10419	15	10908	Glass & Tile Scraper Set	16	11487	Label set for #10225 Step-Up Bench	24
10458	Hopper Gun	18	10916	6" Painter's Taping Knife SS	26	11488	Label set for #10226 Step-Up Bench	24
10459	Replacement Handle, Pin & Clip for #10458	18	10918	PROGRIP® 8" Painter's Taping Knife SS	26	11489	Label set for #10227 Step-Up Bench	24
10460	Replacement Nozzles & Retaining Ring for #10458	18	10920	PROGRIP® 10" Painter's Taping Knife SS	26	11490	Label set for #10228 Step-Up Bench	24
10461	Replacement O Ring for #10458	18	10922	PROGRIP® 12" Painter's Taping Knife SS	26	11500	Soft Grip Safety Scraper, w/5 blades	16
10462	Adjustable Knob Assembly for #10458	18	10947	+Inside Corner Trowel	29	11505	2" Putty Knife & Sundry Assortment	35
10463	Replacement Gun Needle Kit for #10458	18	10948	+Outside Corner Trowel	29	11541	Mexican Heritage 8" Blue Steel Taping Knife	27
10481	Soft Grip Mini Wire Brush Set	22	10954	1200 Lumen Rechargeable LED Pro Grade Wklt	37	11542	Mexican Heritage 10" Blue Steel Taping Knife	27
10483	Soft Grip 14" Stainless Wire Brush w/ Scraper	22	10955	3000 Lumen LED Professional Grade Worklight	37	11543	Mexican Heritage 12" Blue Steel Taping Knife	27
10485	Soft Grip 12" Steel Wire Brush w/ Scraper	22	10971	PROGRIP® American Craftsman 5-in-1, RWB	4,7,33	11551	Mexican Heritage 8" Stainless Steel Taping Knife	27
10486	Soft Grip 10" Shoe Handle Wire Brush	22	10997	2" Stiff Scraper, Hammer Cap™, Carbon Steel	11	11552	Mexican Heritage 10" Stainless Steel Taping Knife	27
10495	15-in-1 Countertop Display	9, 33	10989U	+850 Lumen Rechargeable LED Worklight	38	11553	Mexican Heritage 12" Stainless Steel Taping Knife	27
10500	Soft Grip Safety 1st™ Scraper, w/ 1 Blade	16	11011	PROGRIP® & Scraper Assortment A	36	20630	+3-in-1 Paint Tote	21
10524	45" Flexible Hopper Boot	18	11012	Putty Knife & Scraper Assortment B	36	20631	+Transparent Replacement Liners	21
10628	12" x 9" Polystyrene Pt Color Test Sheet	18	11013	Putty Knife & Scraper Assortment C	37	20640	1 Gallon Paint Can Lids and Pour Spout	21
10629	18" x 24" Polystyrene Pt Color Test Sheet	18	11022	+1-1/4" Stiff Scraper, Hammer Cap™, Carbon Steel	11	34001	+12" Plastic Paint Guide, 30/Cut Carton	20
10630	12" x 9" Foam Board Pt Color Test Panel	18	11025	Wire Brush Display	35	34016	Graining Tool 1/4" Round	19
10634	Safety Locking Collar, for #10329	25	11029	H.D. Utility Blades, .025", 20 Individual 5 packs	16	34114	Mini Glass Scraper/Razor Blade Holder Carded	16
10736	3" SS Straight Blade Pole Scraper, Thd Hdl	14	11067	Tripod Stand for LED's	10, 30	34129	10 Single Edge Razor Blades in a Dispenser	16
10737	3" SS Bent Blade Pole Scraper, Thd Hdl	14	11079	8" 1/8-Notched Plastic Adhesive Spreader	19, 39	34436	Sanding Block, Carded, 10/Cut Carton	28
10738	4" SS Straight Blade Pole Scraper, Thd Hdl	14	11080	8" Plastic Joint Knife	10, 27	34690	4" Paint-Wall-Floor Scraper, Threaded Handle	15
10739	4" SS Bent Blade Pole Scraper, Thd Hdl	14	11081	Wood Handle 13-5/8" Wire Brush w/Scraper, 3x19	22	34709	+4-Edge Paint Scraper	13
10740	4" SS Flex Joint Knife, Rosewood Handle	9	11082	Wood Handle 13-5/8" Wire Brush, 3x19 row	22	3410108	3-in-1 Stripping Brush	12
10741	6" SS Flex Joint Knife, Rosewood Handle	9	11083	Wood Handle 10" Wire Brush w/Scraper, 4x16 row	22	3410020	60MM (2-3/8") Carbide Scraper, w/ Knob	12
10742	1-1/4" SS Stiff Putty Knife, Chisel Edge, Rosewood	9	11084	Wood Handle 10" Wire Brush, 4x16 row	22	3410482	Soft Grip 14" Steel Wire Brush w/ Scraper	22
10743	3" SS Straight Burn-Off Scraper, 7-3/4" Wood Hdl	14	11085	5-Gallon Metal Paint Grid	21	3410486	10.25" Steel Shoe Handle Wire Brush, 4x16,	22,35
10744	3" SS Bent Burn-Off Scraper, 4-1/2" Wood Hdl	14	11086	+9" Plastic Roller Tray	21	3410487	Steel Wire Scrub Brush w/ Scraper, Threaded	22,35
10745	5-in-1 SS Painter's Tool, Rosewood Handle	9	11088	10" Plastic Joint Knife	10, 27	3410491	Nylon Stripper Brush, 5x11, labeled	22
10747	1-1/2" SS Stiff Putty Knife, Rosewood Handle	9	11090	Painter's Series Pry Bar, w/Hammer Cap™	11,20,34	3410492	Soft Grip Wide Razor Stripper Brush	22
10748	3" SS Stiff Scraper, Rosewood Handle	9	11093	3-in-1 Paint Can Clip, 16/CC	21, 33	3410493	S.S. Stripper Brush, 5x11, labeled	22
10749	3" SS Flex Putty Knife, Rosewood Handle	9	11094	3-in-1 Paint Can Clip, 15/Bkt	21, 33	3410496	Lightweight Pole Sander, Plastic	28
10750	1-1/4" SS Stiff Putty Knife, Rosewood Handle	9	11102	8-in-1 Painter's Tool, Black Blade, RWB	4, 33	3410497	Lightweight Hand Sander, Plastic	28
10751	1-1/4" SS Flex Putty Knife, Rosewood Handle	9	11104	Paint Can Carrier with Magnet & Opener	21	3411434	Combo Pack 1.5" Stiff & 4" Flex Nylon Hdl, Carded	11
10752	2" SS Stiff Putty Knife, Rosewood Handle	9	11123	+3-Pack MULTI Mini Brush Set	22	40124	4" American Pride Flex Joint Knife	7
10753	2" SS Flex Putty Knife, Rosewood Handle	9	11125	+3-Pack STAINLESS STEEL Mini Brush Set	22	40125	5" American Pride Flex Joint Knife	7
10770	Strap-N-Stride™ Alum Stilts 18"-30"	23	11135	Drywall Sanding Sponge	28	40126	6" American Pride Flex Joint Knife	7
10771	Strap-N-Stride Alum Stilts 24"-40"	23	11159	3-in-1 Caulk Tool	22	90101	PROGRIP® 1-1/4" Stiff Chisel Putty Knife	4
10773	Foot/Floor Plate Kit for # 10770 & 10771	23	11160	Soft Grip Steel Wire Brush w/Scraper, 6x10 row	22	90106	PROGRIP® 1-1/4" Flex Putty Knife	5
10774	Floor Pad Kit for # 10770 & 10771	23	11163	+50 Pack Single Edge Razor Blades in Dispens	16	90107	PROGRIP® 1-1/4" Stiff Putty Knife	4
10775	Heel Cup Kit for # 10770 & 10771	23	11172	Bucket Scoop	28	90108	PROGRIP® 1-1/2" Flex Putty Knife	5
10776	Strap Kit for # 10770 & 10771	23	11177	+220 Lumen 3W 4-in-1 LED Worklight, 6/Ctr Disp	40	90109	PROGRIP® 1-1/2" Stiff Putty Knife	4
10783	Bolt/Bearing Overhaul Kit for # 10770 & 10771	23	11179	+220 Lumen 3W Pocket LED Worklight, 12/Ctr Disp	40	90110	PROGRIP® 2" Flex Putty Knife	5
10798	8 Point 18MM Economy Snap-Off Blade Knife	17,33	11185	Folding & Locking Zinc Utility Hobby Knife Ctr Disp	17,33	90111	PROGRIP® 2" Stiff Putty Knife	4
102380	8 Point 18MM Economy Snap-Off Blade Knife	17	11187	Folding & Locking Plastic Utility Knife Counter Disp	17,33	90114	PROGRIP® 3" Flex Putty Knife	5
10799	13 Point 9MM Economy Snap-Off Blade Knife	17,33	11215	Paint Project Lifters	19	90115	PROGRIP® 3" Stiff Scraper	4
102381	13 Point 9MM Economy Snap-Off Blade Knife	17	11220	Painter's Series Pry Bar, 10/Counter Display	11,33	90118	PROGRIP® 4" Flex Joint Knife	5
10801	12-in-1 Folding Knife, The Painter's Blade®	9	11221	6" HD Paint & Wall Scraper w/ 24" Handle	15	90119	PROGRIP® 4" Stiff Joint Knife	4
10805	+8 Point 18MM Snap-Off Blades, 50/Plastic Tube	17	11222	8" Joint Knife w/ Hammer Cap™, Carbon Steel	11,27	90120	PROGRIP® 5" Flex Joint Knife	5
10806	13 Point 9MM Snap-Off Blades, 50/Plastic Tube	17	11223	10" Joint Knife w/ Hammer Cap™, Carbon Steel	11,27	90122	PROGRIP® 6" Flex Joint Knife	5
10807	+Utility Blades, 50/Plastic Dispenser	16	11225	6" HD Rplcmnt Paint & Wlpr Scraper Blades, 5/tube	15	90124	PROGRIP® 4" Flex Joint Knife, Hammer Cap™	5
10808	Utility Blades, 10/Plastic Dispenser	16	11243	13-in-1 Painter's Tool, Painter's Series	11	90125	PROGRIP® 5" Flex Joint Knife, Hammer Cap™	5
10811	Bucket Tree Assortment	32	11265	+160/70 Lumen 3W LED Headlamp, 8/Ctr Disp	41	90126	PROGRIP® 6" Flex Joint Knife, Hammer Cap™	5
10812	Toe Strap Kit for # 10770 & 10771	23	11266	+200 Lumen 3W Clip-On LED Headlamp, 12/Ctr Disp	41	90127	PROGRIP® 1-1/2" Full Flex Putty Knife	6
10813	Ankle Strap & Buckle Kit for # 10770 & 10771	23	11267	370 Lumen Wide Beam LED Headlamp w/Spotlight	40	90128	PROGRIP® 2" Full Flex Putty Knife	6
10814	Ankle Strap Pad Kit for # 10770 & 10771	23	11269	Strainer Bag Squeegee and Pail Scoop	20	90131	PROGRIP® 1-1/4" Full Flex Putty Knife	6
10815	Calf Strap Kit for # 10770 & 10771	23	11277	Soft Grip Linoleum Knife with Cover	30	90133	PROGRIP® 3" Full Flex Putty Knife	6
10822	2 Pack, 1-1/4" Flex Putty Knife	10	11314	+4" Glass & Tile Replacement Blade	16	90135	PROGRIP® 4" Full Flex Joint Knife	6
10824	3" V-Notch Spreader, 2 pack	10,30	11359	4"x4" Drywall Repair Patch	29	90137	PROGRIP® 6" Full Flex Joint Knife	6
10827	Grip & Go™ Mud Pan, 10", 6/CC	29	11360	8"x8" Drywall Repair Patch	29	90173	PROGRIP® 8-in-1 HammerCap™	4,33
10829	3 Pack, Flex Putty Knives	10	11361	2-Pack Plastic Joint Knife Set	27	90175	PROGRIP® 3" Stiff Scraper, Hammer Cap™	4
10830	7-in-1 Spray Wrench	4, 33	11362	Cardboard Spray Shield Holder with Pole	19	90189	PROGRIP® 5-in-1 Painter's Tool	4,33
10831	Wood Paint Paddle	19	11373	High Power LED Headlamp 300/90	41	90199	PROGRIP® 6-in-1 Hammer Cap™	4,33
10832	Perfect Pass™ Joint Knife	11, 29	11378	4500 Lumen LED Worklight	39	90660	PROGRIP® 1-1/2" SS Flex Putty Knife, Hammer Cap™	7
10838	6" Long Nose Pliers	18	11379	7000 Lumen LED Worklight	39	90661	PROGRIP® 1-1/2" SS Stiff Putty Knife, Hammer Cap™	7
10839	6-in-1 Screwdriver	18	11388	9000 Lumen LED Portable 2-Fixture Worklight	39	90662	PROGRIP® 3" SS Stiff Scraper, Hammer Cap™	7
10840	16" Tape Measure	18	11397	Long Handled Scrubbing Brush	22	90663	PROGRIP® 3" SS Flex Putty Knife, Hammer Cap™	7
10841	13 Point 9MM Auto-Retract Snap-Off Knife	17	11400	3-Pack Multi Mini Brush Set	22	90664	PROGRIP® 4" SS Flex Joint Knife, Hammer Cap™	7
10843	Adj. Handle Assembly, for #10329	25	11412	3-Pack SS Mini Brush Set	22	90665	PROGRIP® 5" SS Flex Joint Knife, Hammer Cap™	7
10844	Folding Hinge Assembly, for #10329	25	11441	4000 Lumen LED Rechargeable Worklight	38	90666	PROGRIP® 6" SS Flex Joint Knife, Hammer Cap™	7
10845	A Frame Leg Holder, for #10329	25	11443	2000 Lumen LED Worklight	38	90667	PROGRIP® 4" SS Stiff Joint Knife, Hammer Cap™	7
10846	Perfect Pass™ Countertop Display	11,29,33				95108	PRO-STAINLESS 1-1/2" Putty Knife	7
10847	12-in-1 Folding Knife Countertop Display	9, 33				95114	PRO-STAINLESS 3" Putty Knife	7
10848	Mexican Heritage 6-in-1 Countertop Display	7, 33				95124	PRO-STAINLESS 4" Joint Knife	7
10858	Rosewood Series Display	8, 34				95126	PRO-STAINLESS 6" Joint Knife	7
						95173	PRO-STAINLESS 10-IN-1 Painter's Tool	7

Bull Dog Power Products® Lighting 38-45
Power Towers—Metal Halide Light Carts & Bulb 38-39
Halogen Bulbs 39
LED Series—Light Towers/Carts 40-41
LED Series—Rechargeable 42
LED Series—AC Corded 43
LED Series—Battery 44
LED Series—Headlamps 44-45

Items shaded in Blue denote Made in the USA



WARNER®

Warner Tools Products

13435 Industrial Park Blvd.
Plymouth, MN 55441

Phone: 763-559-4740 or 800-234-7708

Fax: 800-455-9883

www.warnertool.com

Customer Service: 800-444-0606

customerservice@warnertool.com



by warnertools

4/11/2024